



The Sollatek **PowerBack** PB3000S / PB5000S

Inverter With Solar Charger Controller

User Instructions

Important: This manual contains important safety instructions.
Keep this manual handy for reference.

- Before using this product please read all instructions carefully.
 - Keep these instructions for future reference.
- All specifications are subject to change without prior notice.

Sollatek[™]
the power to protect

Important Safety Warning



WARNING: This chapter contains important safety and operating instructions. Read and keep this User Guide for future reference.

General Precautions

1. Before using the unit, read all instructions and cautionary markings on:
(1) The unit (2) the batteries (3) all appropriate sections of this manual.
2. **CAUTION** --To reduce risk of injury, charge only deep-cycle lead acid type rechargeable batteries. Other types of batteries may burst, causing personal injury and damage.
3. Do not expose the unit to rain, snow or liquids of any type. The unit is designed for indoor use only. Protect the unit from splashing if used in vehicle applications.
4. Do not disassemble the unit. The maintenance information is only for service technicians. When service or repair is required, contact your supplier for further arrangements. Incorrect re-assembly may result in a risk of electric shock or fire.
5. To reduce risk of electric shock, disconnect all wirings (AC mains, batteries, solar panel) before attempting any maintenance or cleaning. Turning off the unit might not eliminate the risk.
6. No terminals or lugs are required for hook-up of the AC wiring. AC wiring must be no less than 10 AWG gauge copper wire and rated for 75°C or higher.(Refer to equivalence table on page 10). Battery cables must be rated for 75°C or higher and should follow the recommendation in the manual. Crimped and sealed copper ring terminal lugs (refer to INSTALLATION section) should be used to connect the battery cables to the DC terminals of the unit. Soldered cable lugs are also acceptable.
7. Be cautious when working with metal tools on, or around batteries. Dropping a tool and short-circuit the batteries or other electrical parts may result in sparks and explosion.
8. No AC or DC disconnects are provided as an integral part of this unit. Both AC and DC disconnects must be provided as part of the system installation. See INSTALLATION section of this manual.

9. No over current protection for the battery supply is provided as an integral part of this unit. Over current protection of the battery cables must be provided as part of the system installation. See INSTALLATION section of this manual.
10. GROUNDING INSTRUCTIONS -This battery charger should be connected to a grounded permanent wiring system. For most installations, the Ground Lug should be bonded to the grounding system at one (and only one point) in the system. All installations should comply with all national and local codes and ordinances.
11. The unit must be installed and maintained by qualified staff. Please read the manual carefully before installations & operations.
12. The unit contains energy source: the batteries and solar. All terminals and sockets may be powered even when the unit is not connected to the mains.

Table of Content

1. Overview	1
1.1 Key Feature.....	1
1.2 Product Outlook	2
1.3 Basic System Architecture	3
2. INSTALLATION	4
2.1 Unpacking and Inspection.....	4
2.2 Remove bottom cover	4
2.3 Placement	4
2.4 Battery Connection	5
2.5 AC Connection	7
2.6 PV connection	9
3. OPERATION	11
3.1 LCD display introduction	11
3.2 LCD display setting:.....	15
3.3 Standby Charging Mode.....	15
3.4 Operation Modes (after powered on)	16
3.5 Fault Mode.....	19
4. SPECIFICATION	19
APPENDIX A	25
APPENDIX B	28

1. Overview

This is a pure sine wave stand-alone inverter/charger system combining the function of inverter, solar charger and AC charger, and provides a long run-time uninterruptible power supply. Its comprehensive LCD display provides system status, and allows users to set output source priority, charger source priority, charger current and so on.

1.1 Key Feature

- High-frequency switching technology for compact size and light weight
- Pure sine wave output for wide range of applications and harsh environment
- Build-in solar charger controller with MPPT technology to optimize the power utilization
- High efficient DC-to-AC conversion minimizing energy loss
- Standby Charging Mode enables battery charging even when the unit is switched off
- Intelligent cooling fan control
- Input/output isolated design for the maximum operation safety
- LCD displays comprehensive operation status
- Configurable output source priority, charger source priority, charger current and so on.
- Supports Home Appliances / Office Equipment/ Lighting Equipment/ Motor-based Equipment (such as Fan, Air-Conditioner, Washing Machines)
- Thorough protections: Input low voltage / Overload / Short circuit / Low battery alarm / Input over voltage / Over temperature/SCC over current protection
- Rack design & wall-mounted design for flexible installation

1.2 Product Outlook

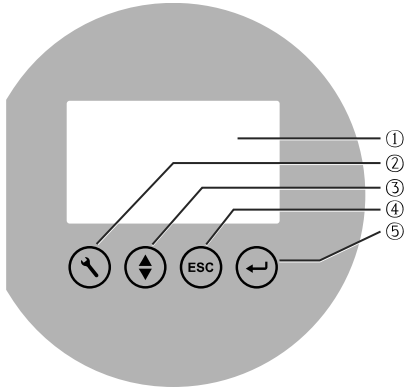

3K rear panel

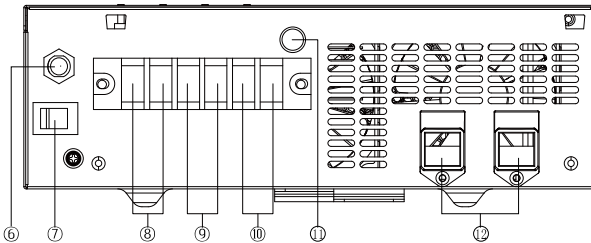

5K rear panel

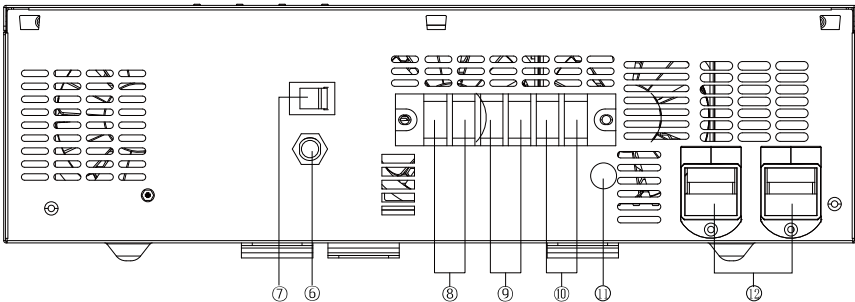

1. LCD display
2. LCD Configuration button: Enter configuration mode, and switch between setting menus
3. LCD up/down button: Move to previous/next setting option
4. LCD ESC button: Return to main menu

5. LCD Enter button: Confirm setting
6. AC input circuit breaker
7. Power ON/OFF switch
8. PV input
9. AC input
- 10.AC output
- 11.AC Input & output GND
- 12.Battery input

1.3 Basic System Architecture

A typical application diagram for home and office applications is as shown below.

The inverter supports the following power sources as input:

- Generator or AC utility
- PV modules(optional)
- Batteries

And the inverter is capable of supplying various loads such as fluorescent lamp, fan, TV, refrigerator, air conditioner and so on.

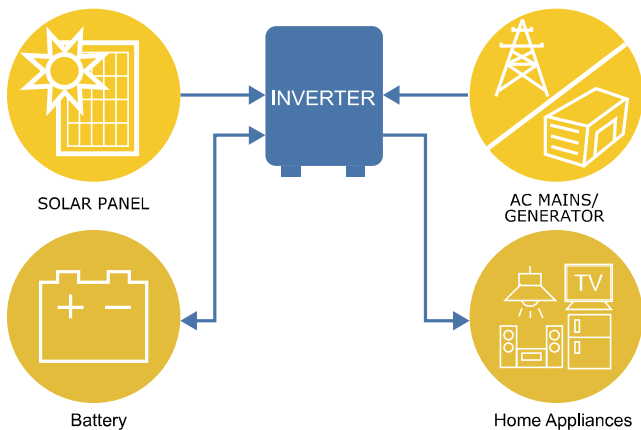

2. INSTALLATION

2.1 Unpacking and Inspection

The product package is shipped with the following items. Please call your supplier or dealer if any items are missing.

- 1 X Inverter
- 1 X DC red cable
- 1 X DC black cable
- 1 X User's manual

2.2 Remove bottom cover

Please take off bottom cover by removing below 2 screws before connecting wires.

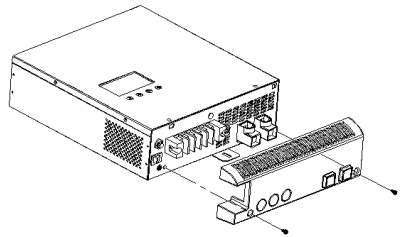

2.3 Placement

Choosing a location to install, the place should be a firm wall and a well-ventilated room protected against rain, vapor, moisture and dust. The location should provide adequate air flow around the Inverter with 30cm minimum clearance on all sides for proper ventilation.

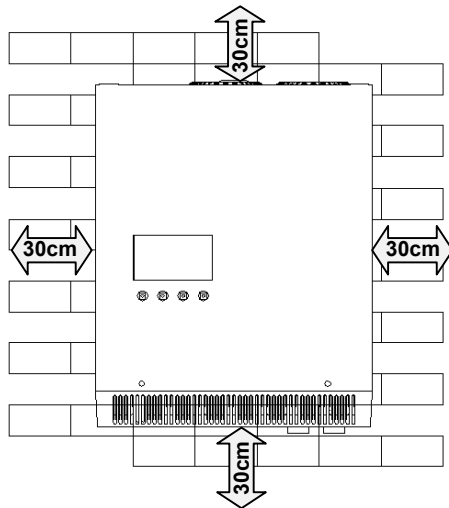

Use screws to mount the inverter to a solid surface. The recommended screw size is M4*50~65mm.

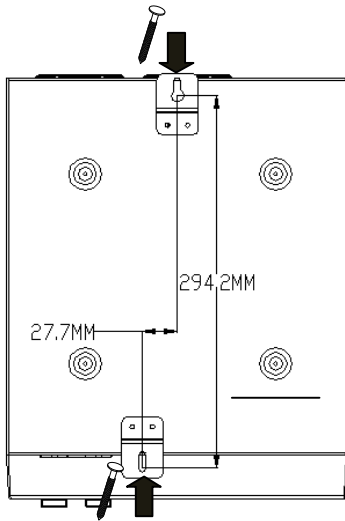

Screws locations of 3K model

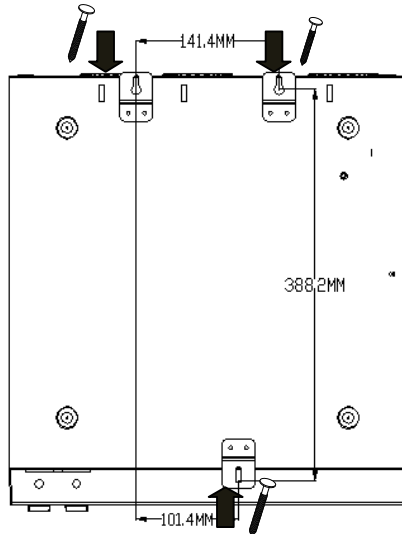

Screws locations of 5K model

2.4 Battery Connection

CAUTION: For safety operation and regulation compliance, it is requested to install a separate DC over-current protector or disconnect device between battery and inverter. Note that some installation requirements may not require a disconnect device, however, an over-current protection installed is still required. Please refer to typical amperage in below table as required fuse or breaker size.



WARNING! All wiring must be performed by a qualified technician

WARNING! Check the polarity before connecting the battery wires in order not to damage the inverter.

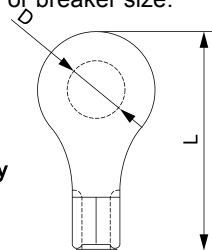

Recommended battery cable & cable terminal size:

Model Number	Typical Amperage	Battery Capacity	Wire Size	CABLE TERMINAL			Torque value
				Cable mm ²	Dimensions		
					D(mm)	L(mm)	
PowerBack PB3000S	110A	200AH	1*4AWG	22	6.4	35	5~ 8 Nm
			2*6AWG	28	6.4	35	5~ 8 Nm
PowerBack PB5000S	100A	200AH	1*4AWG	22	8.4	35	5~ 8 Nm
			2*6AWG	28	8.4	35	5~ 8 Nm

Please follow below steps to connect the batteries:

Step 1 - Install a DC Circuit Breaker for positive (+) battery cable. The rating of the DC Circuit Breaker must be at least 140Amp for POWERBACK PB3000S, 120Amp for POWERBACK PB5000S to guarantee safe operation without interruption. Keep the DC Circuit Breaker off.

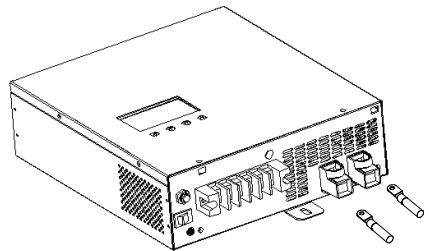

Step 2 - Connect a red cable to **BAT+** terminal, and a black cable to **BAT-** terminal of the inverter.

Knock off below “BAT+” and “BAT-” holes, cross red cable via “BAT+” hole and cross black cable via “BAT-” hole.

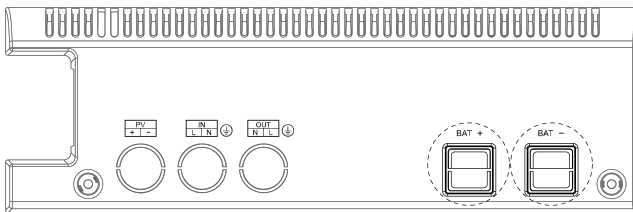

Step 3 - Connect the above mentioned red cable to the battery’s positive (+) terminal and black cable to battery’s negative (-) terminal.

Step 4 - After AC input and output wires are connected, switch on the DC Circuit Breaker.

Note: Make sure the battery voltage meets the inverter’s specification: POWERBACK PB3000S supports 24VDC battery system; POWERBACK PB5000S supports 48VDC battery system. And use at least 200Ah capacity battery for POWERBACK PB3000S & POWERBACK PB5000S.

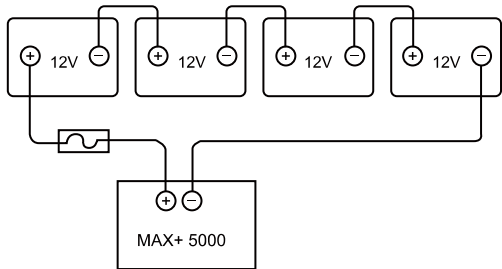
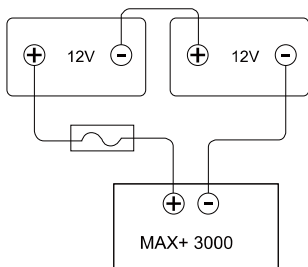

2.5 AC Connection

CAUTION: Please install a separate AC breaker between inverter and AC input power source. This will ensure the inverter can be securely disconnected during maintenance and fully protected from over current of AC input. The recommended spec of AC breaker 30A for POWERBACK PB3000S model, 40A for POWERBACK PB5000S model. Be sure that AC source is switched off before installing the circuit breaker.

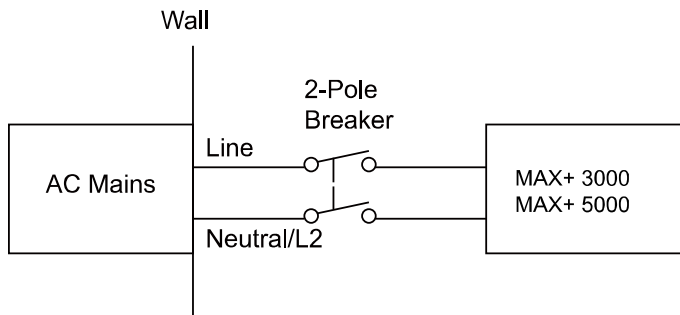

CAUTION: Since the inverter doesn't have an automatic protection device against back feed current. We recommends installing an external AC contactor (see the diagram below). A warning label shall be attached on such AC contactor to remind the user to disconnect the inverter before accessing the circuit.

The rated voltage and current of the AC contactor shall be no less than the inverter's rated voltage and current, and a minimum 1.6mm space clearance shall be reserved.

A circuit breaker shall be installed between AC mains and the inverter in order to disconnect the AC mains when needed. Surge protection is built in. For further protection however, we recommend installing a Sollatek DSP and Sollatek AVS. Contact us for further information.

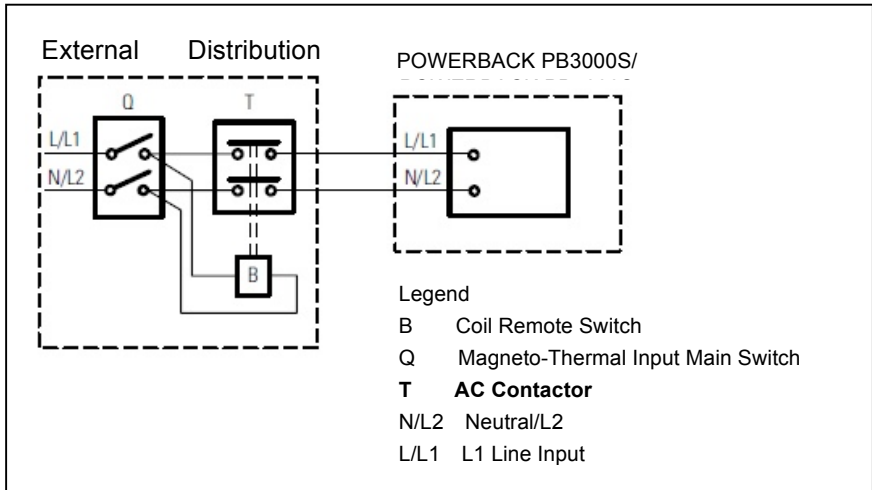

Please follow the steps below to connect AC wires:



WARNING! All wiring must be performed by a qualified technician.

WARNING! Operation without a proper grounding connection may result in electrical shock.

Step 1 - Disconnect the unit from the battery either by turning off the battery circuit breaker or removing the battery cables from the battery. Note that turning the unit off does not disconnect the batteries.

Step 2 - Remove bottom cover and knock off “PV”, “IN” & “OUT” holes.

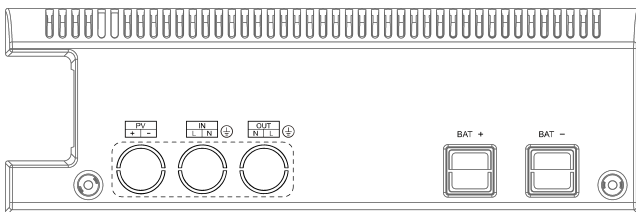

Step 3 - Thread the AC input wires through “IN” hole of bottom cover and AC output wires through “OUT” hole, then connect the AC input wires to input terminal, AC output wires to output terminal & AC GND: GND (green/yellow), Line (brown or black), and neutral (blue) wires.

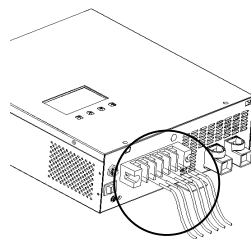
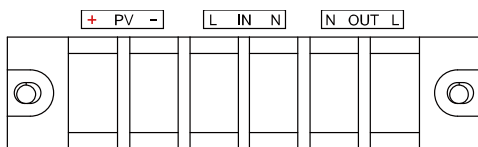

Step 4 - Fix the bottom cover with two screws.

The recommended wire gauge and fixing torque are as below,

Model Number	AC Input Wires Gauge	AC Output Wires Gauge	AC GND Wires Gauge	Torque
POWERBACK PB3000S	12 AWG	12 AWG	12AWG	1.2~1.8 Nm
POWERBACK PB5000S	10 AWG	10 AWG	10AWG	1.2~1.8 Nm

WARNING! The inverter is designed to be operated alone and is not designed for parallel connection. Please **DO NOT** connect the inverter in parallel with any other equipment.

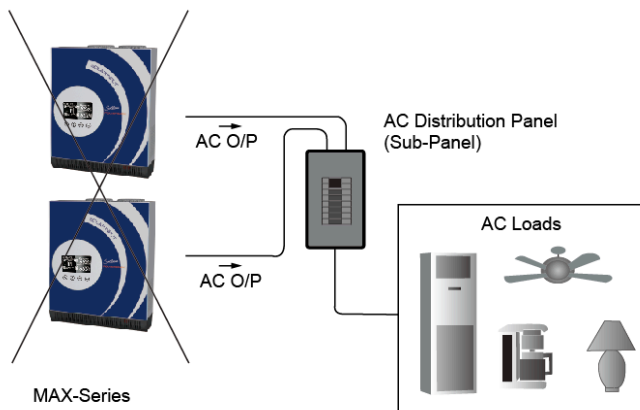

2.6 PV connection

PV panel selection

PV string is a connection of PV panels whose output voltage and current vary under different illumination. And just like battery, the PV panel can be connected in either series or parallel as per needed. Please consult the supplier of PV panel so that the operational voltage and current fall within the allowed range of the inverter as set out in the specification.

Connect PV strings

CAUTION: As the PV string generates power as long as there is light, a circuit breaker with 60A rating shall be installed as shown below, so that PV string can be disconnected when needed (e.g. regular maintenance).

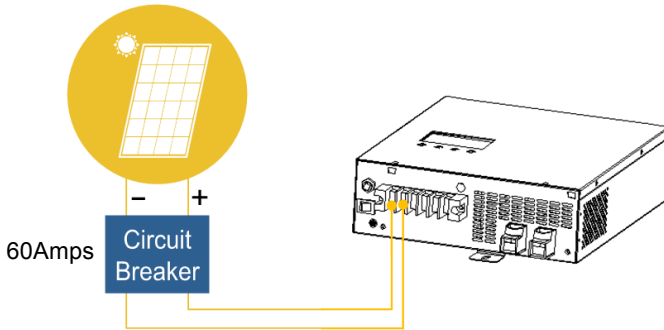

Please follow below step to implement PV module connection:



WARNING! All wiring shall be performed by a qualified technician.

WARNING! Please do not use PV panel which requires one terminal connected to ground (e.g. thin-film panel).

Step 1 - Disconnect the unit from the battery either by turning off the battery breaker or removing the battery cables from the battery. Note that turning the unit off does not disconnect the batteries.

Step 2 - Remove bottom cover & knock off "PV" hole.

Step 3 - Thread the wires through "PV" hole on bottom cover, and then connect the PV string wires to PV input terminals. Check the polarity of wires before connecting to terminals.

Step 4 - Fix bottom cover with two screws.

Step 5 - Turn on battery breaker or connect battery cable.

The recommended wire gauge and fixing torque are as below,

Model Number	PV Input Wire Gauge	Torque
POWERBACK PB3000S	10 AWG	1.2~1.8 Nm
POWERBACK PB5000S	10 AWG	1.2~1.8 Nm







3. OPERATION

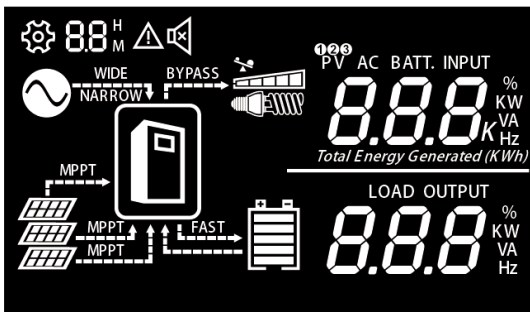



After connecting batteries, AC input cables, and loads, the inverter is now ready to work.

3.1 LCD display introduction

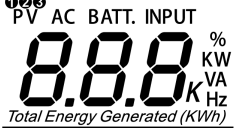



LCD displays the power flow and input/output readings in a visualized graphic design which allows the user to understand the operation status easily.









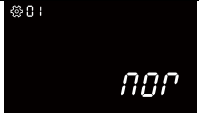

Icon	Description
	This icon is showed when AC input (from AC mains or generator) presents.
	If unit is on wide mode, "WIDE" will be lighted, else "NARROW" will be lighted.
	This icon is showed when PV (solar) system presents.
	The icon indicates level of remaining battery capacity
	The icon indicates battery flow way. If unit is on CC & CV charging stages, "FAST" will be lighted.
	The icon indicates output load level. If unit work on line mode, "BYPASS" will be lighted.
	Indicate PV input voltage. PV input current, AC input voltage, Battery voltage.





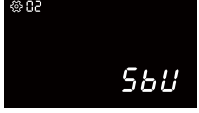
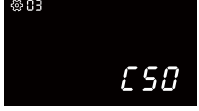

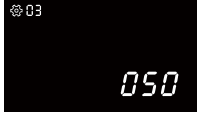
<p>LOAD OUTPUT</p> 	<p>Indicate output voltage, output frequency, load percentage, load VA value, load watt value.</p>
	<p>The icon indicates unit is on LCD setting mode.</p>
	<p>The icon indicates unit is on alarm mode or fault mode.</p>
	<p>When unit is on LCD setting mode, it indicates program code. When unit is on fault mode, it indicates the fault code which can be referred to specific fault event (please refer to Section “Troubleshooting”).</p>

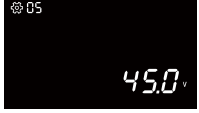



(2) Setting Menus

After pressing and holding  button for more 2 seconds to enter setting mode, press  button for 1 second to select setting programs, then press  button to select program option, then press  button to confirm the selection or **ESC** button to exit.

Program	Description	Selectable option & behavior	LCD setting display
01	AC input voltage range	Wide (default): If selected, acceptable A C input voltage range will be within 90-280VAC	
		Narrow : If selected, acceptable AC input voltage range will be within 170-280VAC	
		Generator : If selected, acceptable AC input voltage range will be within 90-280VAC	
02	Output source priority: To configure load power source priority	Solar first (default): Solar energy provide power to the loads as first priority. If solar energy is not sufficient to power all connected loads, battery energy will supply power the load at the same time. Utility provides power to the loads only when any below condition happens: -Solar energy is not available -Battery voltage drop to either low-level warning voltage or the setting point in program 5.	



		<p>Utility first: Utility will provide power to the loads as first priority. Solar and battery energy will provide power to the load only when utility power is not available.</p>	
		<p>SbU: Solar energy provides power to the loads as first priority. If solar energy is not sufficient to power all connected loads, battery energy will supply power the load at the same time. Utility provides power to the loads only when battery voltage drop to either low-level warning voltage or the setting point in program 5.</p>	
03	Charger source priority: To configure charger source priority	<p>Solar first: Solar energy will charge battery as first priority. Utility will charge battery only when solar energy is not available.</p>	
		<p>Utility first: Utility will charge battery as first priority. Solar energy will charge battery only when utility power is not available.</p>	
		<p>Solar and Utility(default): Solar energy and utility will charge battery at the same time.</p>	
		<p>Only solar: Solar energy will be the only charger source no matter utility is available or not.</p>	
04	Setting voltage point back to battery mode when selecting "SBU priority" or "Solar first" in program 2.	<p>Options in POWERBACK PB3000S model: Full/25.0V/25.5V/26.0V/26.5V/27.0V(default)/27.5V/28.0V.</p> <p>Options in POWERBACK PB5000S model: Full/50V/51V/52V/53V/54V(default)/55V/56V.</p>	
05	Setting voltage point back to utility source when selecting "SBU priority" or "Solar first" in program 2.	<p>Options in POWERBACK PB3000S model: 21.0V/21.5V/22.0V(default)/22.5V/23.0V/23.5V/24.0V/24.5V.</p> <p>Options in POWERBACK PB5000S model: 42V/43V/44V(default)/45V/46V/47V/48V/49V.</p>	

06	Max charging current: To configure total charging current for solar and utility chargers: (Max. charging current=utility charging current +solar charging current)	Options in POWERBACK PB3000S model: 20A/30A/40/50A/60A(default)/70A/80A/90A/100A Options in POWERBACK PB5000S model: 20A/30A/40/50A/60A(default)/70A/80A/90A/105A	
07	Max utility charging current	Options in POWERBACK PB3000S model: 0A/2A/10A/20A(default) Options in POWERBACK PB5000S model: 0A/2A/10A/25A (default)	
08	Auto restart when overload occurs	Restart disable(default): When unit is overload, unit will release overload alarm, then turn off output & release fault alarm, unit won't restart again until end-user reduce load & press unit's on/off power switch.	
		Restart enable: When unit is overload, overload alarm 5 seconds and turn off output for 15 seconds, then restart unit again. The restart cycle is 5 times.	
09	Low DC cut off voltage	Auto(default): If setting auto, low DC cut off voltage will be relate to load percent. 20.0V for 24V model @ >=60%load 21.0V for 24V model @ <60%load 40.0V for 48V model @ >=60%load 42.0V for 48V model @ <60%load	
		24V model: 20.0V to 24.0V, 0.2V per step; 48V model: 40.0V to 48.0V, 0.4V per step.	

10	LCD backlight control	Backlight auto(default): LCD backlight will be off when no LCD button is pressed after 1min.	
		Backlight all on	
11	Recover manufactory setting	Recover enable: Return to manufactory default setting.	
		Recover disable(default)	

3.2 LCD display setting:

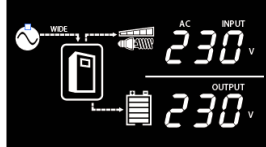
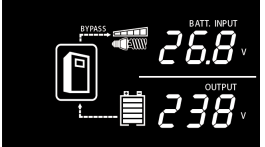
The default LCD display is:

Line mode	Battery mode	BAT+PV mode
		

The LCD display content will be changed in turns by pressing \blacktriangledown button. The selectable information is switched as below order: PV input voltage, PV input current, AC input voltage, battery voltage, output voltage, output frequency, load percentage, load VA value, load watt value. LCD will return to default LCD display after 1 minute, or press **ESC** button return to default LCD display immediately.

3.3 Standby Charging Mode

The battery can be charged without switching on the inverter, and such operation is called Standby Charging Mode. When AC input cable and battery is connected, the inverter will enter into Standby Charging Mode and LCD will be turned on with the following display. But if charger priority setting is only solar, utility won't charge battery.

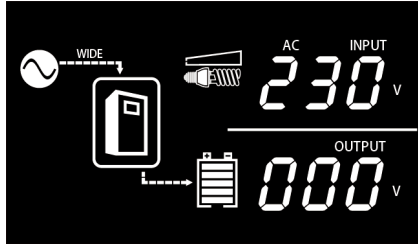

If PV string is also connected with enough voltage, the display will be as shown below to indicate the power flow from PV string. Except only solar setting for charger priority.

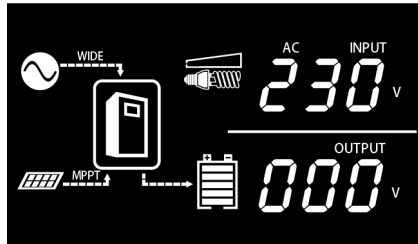



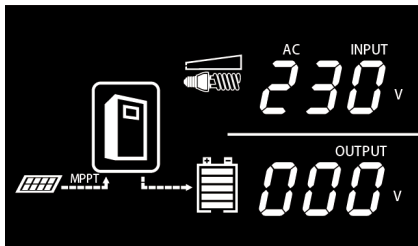

Even if AC input is absent, PV power can still charge the battery and the display will be as shown below.



3.4 Operation Modes (after powered on)

Press the Power ON/OFF button to power on the inverter and the inverter will automatically enter into either of the operation mode according to the condition of AC input and PV input as shown in the table below

	 PV Power present	 Less PV Power	 No PV Power
 AC Input Power Present	LINE MODE 2		LINE MODE 1
 AC Input Power Absent	BACKUP MODE 3	BACKUP MODE 2	BACKUP MODE 1

LINE MODE 1

AC input is present and PV input is absent. Load is supplied by AC input power directly.

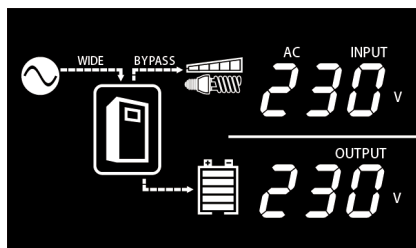

LINE MODE 2

Both AC input and PV input are present. Load is supplied by either AC input or PV input depending on the priority switch's setting.

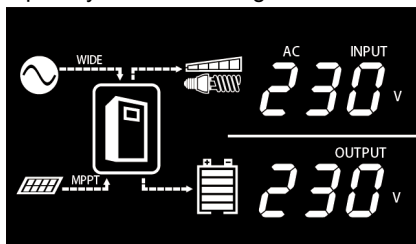

Output source priority setting:

In LINE MODE 2, if priority setting is Solar first or SBU, when PV power is strong enough to support load, the AC input will not be consumed even though it is

present. This is deemed an energy-saving operation.

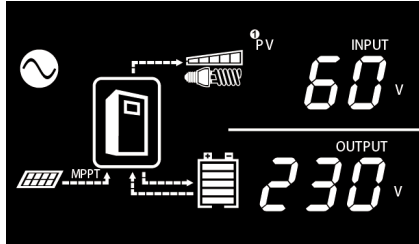

BACKUP MODE 1

Both AC input and PV input are absent. The backup power to load comes only from battery. The backup time is determined by the capacity of battery.

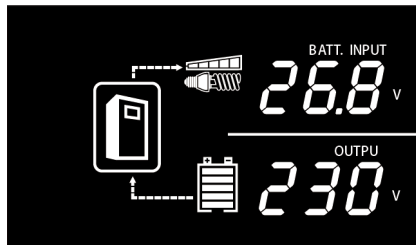

BACKUP MODE 2

AC input is absent and PV power is present, if PV power is not enough to support loads completely. The insufficient power is covered by battery.

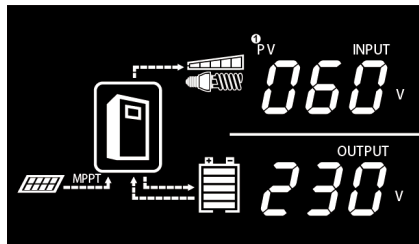

The larger the PV power, the less consumption from battery and therefore the longer backup time.

BACKUP MODE 3

AC input is absent and PV power is present, if PV power is strong enough, it will not only support the load but also charge the battery.

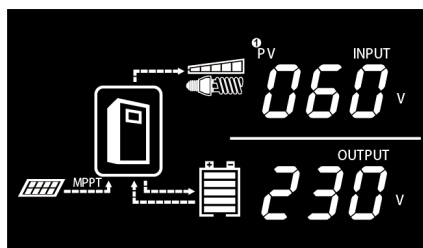

As long as the PV generates power, the load can be powered continuously without consuming power from battery.

3.5 Fault Mode

If unit is on fault mode, LCD will show the fault code which can be referred to specific fault event (please refer to Section “Troubleshooting”).

4. SPECIFICATION

MODEL	POWERBACK PB3000S	POWERBACK PB5000S
CAPACITY	2.4KW/3000VA	4.2KW/5000VA
INPUT		
Input Voltage Waveform	Pure sine wave (utility or generator)	
Nominal Input Voltage	230Vac	
Input voltage range	170Vac-280Vac(Normal); 90Vac-280Vac(Generator/Wide)	
Max AC Input Voltage	300Vac RMS	
Nominal Input Frequency	50Hz / 60Hz (Auto detection)	
OUTPUT		
Wave from	Pure sine wave (Inverter mode)	
Voltage Regulation (Inverter Mode)	±10% RMS	
Output Frequency	50Hz / 60Hz ± 1Hz	
Nominal Efficiency	90% (@Inverter mode with normal DC Input; >60% R load); 95% (@Line mode with Rated R load, battery full charged)	
Capable of starting electric motor	1.5HP	2.5HP
Power Factor	0.8	0.84
Over-Load Protection	Tripped off after 5s@≥150% load Tripped off after 10s@110%~150% load	
Transfer Time (AC to DC)	Normal range : 10ms (typical) 15ms (max) Generator/wide range: 20ms (typical) 40ms (max)	
Power Limitation	POWERBACK PB3000S @ Line mode:	

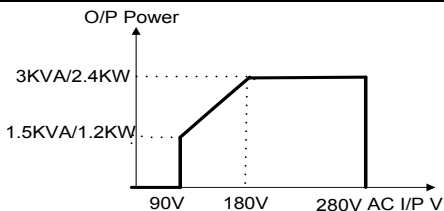

POWERBACK PB5000S@ Line mode:

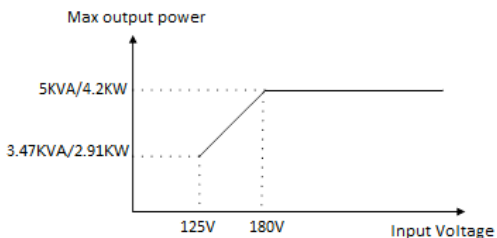

BATTERY		
Battery Voltage	24.0Vdc ± 0.6Vdc	48.0Vdc± 1.2Vdc
Battery low alarm voltage	21.0Vdc ± 0.6Vdc (default)	42.0Vdc± 1.2Vdc(default)
Battery low shut-down voltage	Default: 20.0Vdc ± 0.6Vdc@ load>60% 21.0Vdc± 0.6Vdc@ load<60%	Default: 40.0Vdc ± 1.2Vdc@ load>60% 42.0Vdc± 1.2Vdc@ load<60%
Battery capacity(suggestion)	>=200Ah	
AC CHARGER		
Charger Current	0A/2A/10A/20A selectable	0A/2A/10A/25A selectable
Boost charger voltage (bat. Type)	28.4Vdc	56.8Vdc
Floating charger voltage (bat. Type)	27.4Vdc	54.8Vdc
Over charger Voltage	30.0Vdc	60.0Vdc
SOLAR CHARGER MODULE		
Max. PV Module Charger current	80A	80A
Max PV panel array power(base on 250W/8A PV panel)	2000W	3750W
Max PV mode power rating to support load	1600W	3200W
MAX. PV Input Current	50A	50A
System DC Voltage	24.0Vdc	48.0Vdc

MPPT operating voltage range	30~80Vdc	60~150Vdc
MPPT optimal work voltage range	35~70Vdc	70~120Vdc
Max. PV Array Open Circuit Voltage	80Vdc	150V
AUDIBLE ALARM		
Low Battery at Inverter Mode	Beeps 1 time every 2s	
Overload	110%~150%load: beep 10 times every 0.5s; >150% load: beep 5times every 0.5s then fault.	
Fault	Beeps continuously	
PHYSICAL		
Dimension(D*W*H)mm	342*268.2*94.4mm	436.00*394.4*118.3
Net weight	5.7KG	10.3kg

General Specification

Safety Certification	CE
Operating Environment	0°C to 50°C; 5% to 95% non-condensing
Altitude, operational	Elevation: 0~1500 Meters
Storage temperature	-15°C ~ 60°C

Troubleshooting

Problem	Possible Causes	Remedy
No LCD display	1. Battery weak	1. Re-charge battery
	2. Battery defective (can't be charged)	2. Battery replacement
	3. Power switch is not pressed	3. Press and hold power switch
	4. Battery polarity reversed, can't start up the unit	4. Contact dealer or supplier for service
Mains normal but works in inverter mode	1. AC Input is missing	1. Check AC input connection
	2. Input protector tripped off	2. Reset the input protector
PV input normal but works in inverter mode	1.PV weak	1.Check PV power or reduce loading
	2.PV input is missing	2.Check PV input connection

Alarm buzzer beeps continuously	1. Overload (fault code: F2)	1. Reduce loading so the loads' capacity is no larger than the upper limit
	2. Output short-circuited (fault code: F3)	2. Check wiring or remove abnormal load
	3. Inverter over-temperature (fault code: F5)	3. Check the ventilation at installed location and make sure the air vent of inverter is clear
	4. Over charging (fault code: F1)	4. Restart the unit, If the fault persists, contact dealer or supplier for service.
	5. Fan error (fault code: F4)	5. Check if the fan is blocked by obstacle. if not, contact dealer or supplier for service
	6. DC voltage is under low DC shut-down point (fault code: F0)	6. Make sure mains is normal to recharge the battery
	7. Output abnormal (fault code: F6)	7. Contact dealer or supplier for service
	8. Back-EMF, only for POWERBACK PB3000S/5000model (fault code: F7)	8. Check the AC Input and output wire connection
	9.SCC output over current (fault code: F11)	9.Check wiring or remove abnormal load
	10.SCC over temp(fault code: F12)	10. Check the ventilation at installed location and make sure the air vent of inverter is clear
	11.SCC Output over voltage(fault code: F13)	11. Restart the unit. If the fault persists, contact dealer or supplier for service
	12.SCC PV input over voltage (fault code: F14)	12.Check PV input voltage. If the voltage is normal, contact dealer or supplier for service
	13.SCC Fan Fault (Only for POWERBACK PB5000S) (fault code: F15)	13. Check if the fan is blocked by obstacle. if not, contact dealer or supplier for service
Back up time is shortened	1. Overload	1. Reduce the loading
	2. Battery voltage is too low	2. Charge battery for 8 hours or more
	3. Battery bank is too small	3. Increase battery bank capacity

Note: If the unit fails to operate properly after installation and the setup has been re-examined thoroughly, use the troubleshooting table to determine the probable cause and remedy. For unlisted faults, please contact your local dealer or supplier for service assistances.

Alarm Behavior Table

Fault Code	Protect Function	Active Mode	Condition	Warning (O/P=ON)	Fault (O/P=OFF)	Restart	
						Operate	Condition
--	Low DC Voltage Alarm	Inv. mode	DC voltage<Low DC Alarm	1beep/2s	--	--	--
1	Over Charge Protection	Line mode	DC Voltage>High DC input Shut-down	Beep continuous	--	Manual	--
1	Over Voltage Protection	Standby	DC Voltage>High DC input Shut-down	--	Beep continuously	Auto	DC Voltage<High DC input Shut-down Recovery
2	Over Load Protection	Line/ Inv. mode	110%~150% rated load	1beep/0.5 s,and continue for10s	Beep continuously	Manual	--
			>150% rated load	1beep/0.5 s,and continue for 5s	Beep continuously	Manual	--
3	Output Short Circuit protection	Inv. mode	Output Voltage<20Vrms	--	Beep continuously	Manual	--
4	Inverter Fan Fault Protection	Line/ Inv. mode	Fan Locked Fan Defected	2beep/2s, and continue for 1min	Beep continuously	Manual	--
5	Inverter Over Temp Protection	Line/ Inv. mode	HEAT SINK over temp	--	Beep continuously	Auto	HEAT SINK Temp≤ 55□
6	Output Abnormal	Inv. mode	(Output Voltage <170Vrms and output current under 32Arms) or Output Voltage >280Vrms	--	Beep continuously	Manual	--
7	Bus Over Protection	Standby/ Line/ Inv. mode	Bus voltage over/ AC Input and output reconnect	--	Beep continuously	Manual	--
11	SCC charger over current	SCC	SCC charger current over 120A	--	Beep 1time/2Second	Manual	--

12	SCC over temp.	SCC	SCC NTC Temperature over 110°C	--	Beep 1time/2Second	Manual	--
13	SCC Output over voltage	SCC	SCC Output voltage over 30V(3K)/60V(5K)	--	Beep 1time/2Second	Manual / Auto	SCC Output voltage lower than 24V(3K)/48V(5K)
14	SCC PV input over voltage	SCC	PV Input voltage over 80V(3K)/150V(5K)	--	Beep 1time/2Second	Manual / Auto	PV Input voltage lower than 70V(3K)/140V(5K)
15	SCC Fan Fault(Only for 5K SCC)	SCC	SCC Fan lock	--	Beep 1time/2Second	Manual	--

Note: when SCC Fault, press ENTER Key will clear this fault message.

- 1) Unit will shut down after alarm for 1min, when unit on both fault mode and Switch-off mode.
- 2) Unit will shut down immediately without any alarm, when unit on Switch-on mode with low DC input.

Input voltage setting:

- (1) **Normal** “170V~280V”for is for valuable electronic devices. If the utility is higher or lower than this range, the unit will transfer to inverter mode automatically.
- (2) Wide “90V~280V” for is for home application. If the utility is higher or lower than this range, the unit will transfer to inverter mode automatically.
- (3) **Generator**, if AC input is connected to a generator, please choose “generator” as “Input range”.

APPENDIX A

How to Select and Configure PV Panels

The following parameters can be found in each PV panel's specification:

- P_{max} : Max output power (W)
- V_{oc} : open-circuit voltage (V)
- I_{sc} : short-circuit current (A)
- V_{mp} : max power voltage (V)
- I_{mp} : max power current (A)

PV panels can be connected in series or parallel in order to obtain the desired output voltage and current which meets the inverter's allowed range.

When connecting PV panels in series, the max voltage and current of the string is

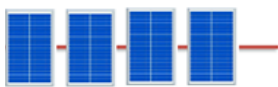

$$V_{string} = V_1 + V_2 + V_3 + V_4 \dots$$

$$I_{string} = I_1 = I_2 = I_3 = I_4$$

When connecting the above PV string in parallel, the max voltage and current of the total string is

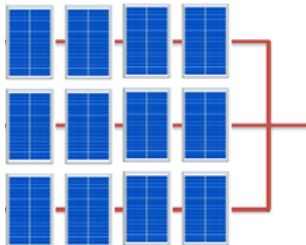

$$V_{total} = V_{string1} = V_{string2} = V_{string3} = V_{string4} \dots$$

$$I_{total} = I_{string1} + I_{string2} + I_{string3} + I_{string4}$$

In either case, the total output power is $P_{total} = P_{panel} \times \text{Number of PV panel}$

The guideline to select and configure PV string is

- P_{total} shall be equal or slightly larger than the max. capacity of solar battery charger (2000W for 3000VA model and 3750W for 5000VA model). Extra capacity in PV string will not increase the charge capacity but only result in higher installation cost.

Model	PV panels installed	Max. PV module to support load
3000VA	2000W	1600W
5000VA	3750W	3200W

- Total V_{mp} of the string shall be within the operating voltage range of solar battery charger (35~70V for 3000VA model and 70~120V for 5000VA model are recommended).

Model	PV Operating voltage range	PV Optimize working voltage range
3000VA	30~80Vdc	35~70Vdc
5000VA	60~150Vdc	70~120Vdc

Example 1 - How to connect 3000VA model to PV panels with the following parameters?

- P_{max} : 250W
- V_{mp} : 30.96V
- V_{oc} : 36.6V
- I_{mp} : 8.07A
- I_{sc} : 8.75A

- The max. PV input power for 3000VA model is 2000W,
 $2000W / 250W = 8 \Rightarrow$ min. 8 PV panels shall be connected.
- Best Operating Voltage Range is 35~70V,
 $70V / 30.96V = 2.26 \Rightarrow$ max. number of PV panel in series is 2.
- Taking (1)~(2) into consideration, the optimized configuration is 2 PV panels in series as a string and 4 strings in parallel, as shown below.

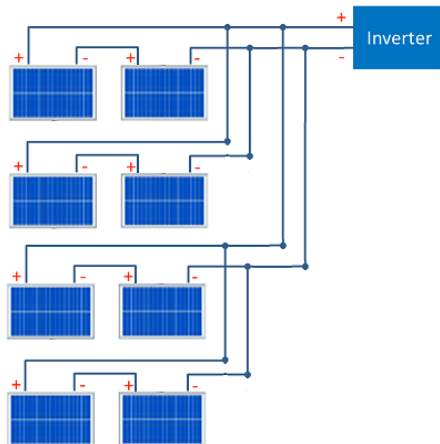

- Check again the V_{oc} and I_{sc} of PV string,

V_{oc} of string is $73.2V < 80V$ (Max. PV Input Voltage) \Rightarrow OK

I_{sc} of string is $4 \times 8.75A = 35A < 50A$ (Max. PV Input Current) \Rightarrow OK

Example 2 - How to connect 5000VA model to PV panels with the following parameters?

- P_{max} : 250W
- V_{mp} : 30.96V
- V_{oc} : 36.6V
- I_{mp} : 8.07A
- I_{sc} : 8.75A

- (1) The max. PV input power for 5000VA model is 3750W,
 $3750W / 250W = 15 \Rightarrow$ min. 15 PV panels shall be connected.
- (2) Best Operating Voltage Range is 70~120V,
 $120V/30.96V = 3.87 \Rightarrow$ max. number of PV panel in series is 3.
- (3) Taking (1)~(2) into consideration, the optimized configuration is 3 PV panels in series as a string, and 5 strings in parallel (as shown below).

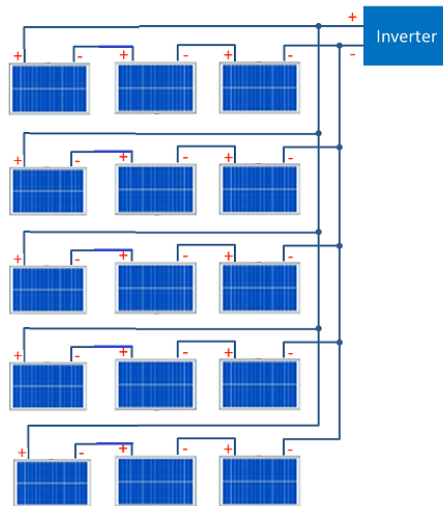

- (4) Check again the V_{oc} and I_{sc} of PV string,
 V_{oc} of string is $3 \times 36.6V = 109.8V < 150V$ (Max. PV Input Voltage) \Rightarrow OK
 I_{sc} of string is $5 \times 8.75A = 43.75A < 50A$ (Max. PV Input Current) \Rightarrow OK

APPENDIX B

HOW TO DETERMINE THE OUTPUT SOURCE PRIORITY SETTING AND CHARGER SOURCE PRIORITY SETTING?



Please read this document carefully if you intend to manually set the priority setting of the product. Improper setting might compromise the function and performance of the product.

The product is designed to accept both utility and solar (PV) power as input source, and it also provides a function allowing the user to determine the priority between utility and solar input power. The priority is to be set via LCD and control buttons on the front panel (please refer to user manual for more details). This document explains how the product's behavior will be at each setting and what should be considered while determine the priority.

A. Output source priority setting

1. Setting Utility as output source priority

1.1 When utility is normal

The loads connected to the product are supplied by utility power only, even when solar power presents.

1.2 When utility is down

As soon as the utility is down, the inverter enters into "Backup Mode" and checks both solar power and battery's status. If solar power is strong enough, it will supply the loads. If solar power becomes weak, the loads will then be supplied by battery until it's too low. The longer the solar power lasts, the less consumption from the battery and hence the longer backup time.

Advantages	Disadvantages/Risk
Better chance to keep the battery fully-charged so that the backup function won't be compromised when the utility is down. Good for batteries life as batteries are less chance to work on discharging mode.	The solar power cannot be fully utilized by supporting the loads, especially when battery is fully charged.

2. Setting Solar as Priority

2.1 When utility is normal

As long as solar power is strong enough to support the, utility power will not be consumed even though it's available. If solar power is not enough, battery will firstly come up to support the loads, and after battery is low or the setting point in program 5, utility will then take over to support the loads. If solar is absent, utility will then take over to support the load too.

2.2 When utility is down

The behavior is the same as 1.2.

Advantages	Disadvantages
The good utilization of solar power. Save electricity bill by reducing the consumption of utility	Battery will experience more frequent charge and discharge cycles and therefore battery's service life will be shorter. If both solar power and battery is low, and utility outage occurs before the battery can fully-charged by utility, the backup function of the product might be compromised or void.

3. Setting SbU as Priority

3.1 When utility is normal

As long as solar power is strong enough to support the loads, utility power will not be consumed even though it's available. If solar power is not enough, battery will firstly come up to support the loads, and after battery is low or the setting point in program 5, utility will then take over to support the loads and charge the battery.

2.2 When utility is down

The behavior is the same as 1.2.

Advantages	Disadvantages
The utilization of solar power is maximized. Save electricity bill by reducing the consumption of utility	Battery will experience most frequent charge and discharge cycles and therefore battery's service life will be shorter. If both solar power and battery is low, and utility outage occurs before the battery can fully-charged by utility, the backup function of the product might be compromised or void.

Summary

Whether setting utility as priority or setting solar or SbU as priority is subject to purpose of installing the product. In the event the product is to be installed in areas where the utility power is unstable and backup function is much important than energy saving, utility shall be set as priority.

If the product is to be installed in areas with stable utility power and strong sunlight, and energy saving is more concerned than backup function, solar power shall be set as priority or SbU.

B. Charger source priority setting

1. Setting Utility as charger source priority

Utility first: Utility will charge battery as first priority.

Solar energy will charge battery only when utility power is not available.

2. Setting Solar as charger source priority

Solar energy will charge battery as first priority.

Utility will charge battery only when solar energy is not available.

3. Setting only Solar as charger source priority.

Solar energy will be the only charger source no matter utility is available or not.

4. Setting only Solar and Utility as charger source priority.

4.1 When utility is normal

Solar energy and utility will charge battery at the same time.

4.2 When utility is down

Solar energy will charge battery.

Summary

Whether setting which option as charger source priority subject to purpose of installing the product. In the event the product is to be installed in areas where the utility power is unstable and backup function is much important than energy saving, Solar and Utility or Utility shall be set as charger source priority.

If the product is to be installed in areas with stable utility power and strong sunlight, and energy saving is more concerned than backup function, solar first or only solar shall be set as priority, and set the maximum utility charging current as small current as possible (program 7), for example: 2A.



SOLLATEK UK LTD.

Tel: +44 (1753) 214 500
sales@sollatek.com
www.sollatek.com

Sollatek (UK) Ltd. Sollatek House, Waterside Drive, Langley, Slough SL3 6EZ UK

ISO9001: 2008 accredited company

All weights and dimensions are approximate. Specifications are subject to change without prior notice. ©Sollatek (UK) Limited 2012. All Rights Reserved. SOLLATEK and the SOLLATEK device are the trade marks of the Sollatek group of companies.