

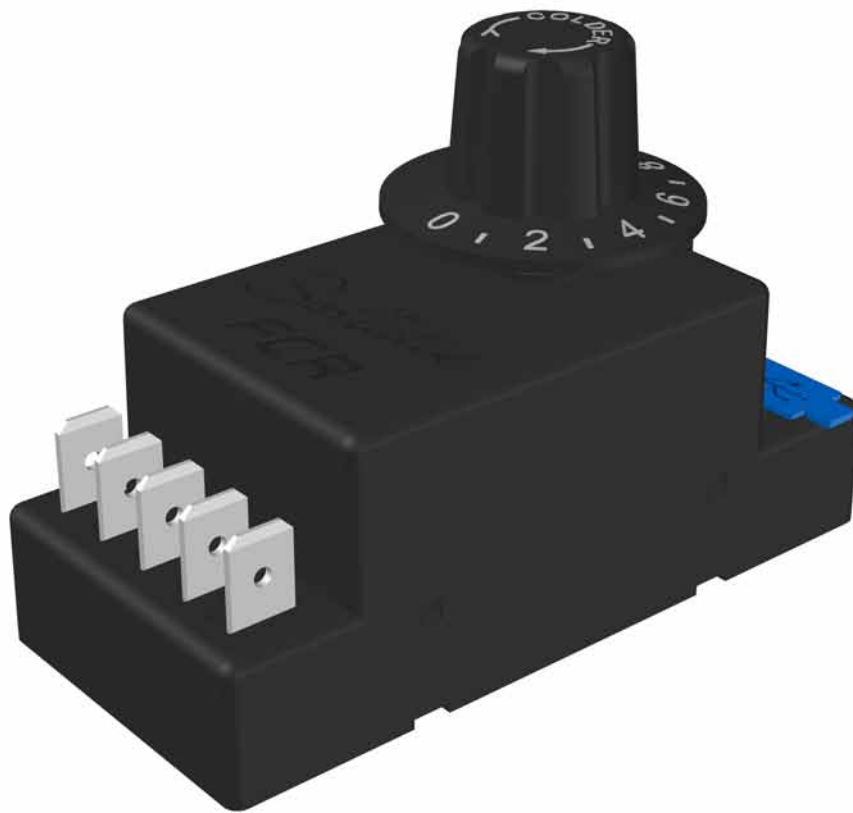

The Sollatek FreoCom FCR32

Microprocessor-controlled thermostat and voltage protector

Instruction manual



Important: This manual contains important safety instructions.
Keep this manual handy for reference.

- Before using this product please read all instructions carefully.
- Keep these instructions for future reference.
- All specifications are subject to change without prior notice.

1. Introduction

The FreoCom FCR32 can control up to three separate and independent outputs (compressor, Aux1 & Aux2) and read up to two temperature probes. Aux1 & Aux2 can be used to control an evaporator fan, defrost heater, lights, condenser fan, or any other application. Refer to Section 8 "Connections to FreoCom" for more details on the usage of different outputs. The product code is FCRxy, where x represents the number of outputs to control and y represent the number of available temperature probes to read.

The FreoCom provides very accurate temperature control, energy saving, time and active defrost control and protects equipment by disconnecting the mains supply when it goes either below or above pre-set acceptable limits. It provides reliability and immunity from environmental factors such as humidity and altitude.

These factors make the FreoCom the total solution for all refrigeration equipment.

2. Overview

2.1 Overall view

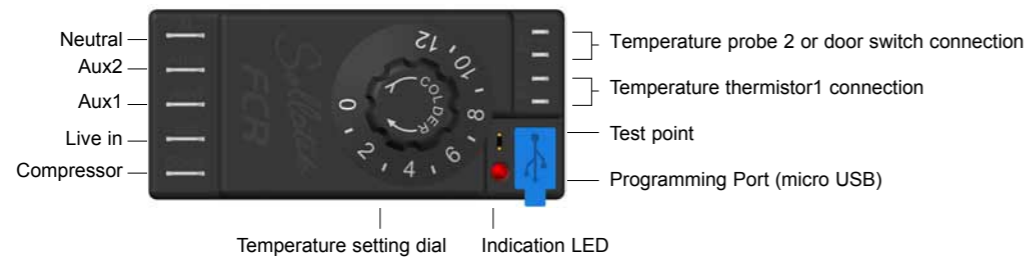

FCRxy

x: The number of outputs to control

y: The number of temperature probes to read

2.2 LEDs description

FCR LED Flashing Pattern & meanings:

LED Pattern	Meaning
Solid ON	On mode (in cooling demand, voltage is good, compressor is ON)
Flashing 0.5 sec ON/0.5 sec OFF	Bad voltage (outputs are OFF)
Flashing 1 sec ON/1 sec OFF	Wait & Cooling Demand (temperature > cut-in, waiting for the time delay to be over to switch the compressor ON)
Flashing 2 secs ON/2 secs OFF	Wait & Temperature Satisfied (waiting for the temperature to rise above cut-in)
Flashing 4 secs ON/4 secs OFF	Defrost mode (compressor is OFF)
Blinking fast once every 2 secs	Probe#1 is faulty
Blinking fast twice every 2 secs	Probe#2 is faulty
3 Flashes Ascending Order	Dial OFF position (all outputs are OFF)
Momentarily OFF	In Under Voltage Blind Time or Over Voltage Blind Time (compressor is ON, voltage is outside the limits but still within UVBT or OVBT)
Flashing 0.1 sec ON/0.1 sec OFF	Bad mains frequency (outputs are OFF)

3. Temperature control

The FreoCom is a microprocessor-based temperature controller utilising up to two NTC (Negative Temperature Coefficient) probes. The cooler temperature is determined by measuring the temperature of either the return airflow or evaporator temperature depending on where the customer prefers to fit the probe.

The cooler set temperature is achieved by setting the control dial fitted in front of the FreoCom unit taking the required differential into consideration.

For further information please refer to the comprehensive diagram found on the middle pages and to the Parameters Configuration section for full list of parameters that can be configured.

4. Energy saving

There are three ways where the unit can provide energy saving:

- Cycling the evaporator fan (when controlled by an output) On/Off during the operation of the cooler as opposed to keeping it On all the time.

- Activating Setback Mode whereby the temperature set points are set to higher limits than they are in normal mode, therefore the regulated temperature will be higher than what it is used to

be and less cooling demand will be required by the compressor resulting in saving energy.

Setback Mode can be activated when a door switch has been closed for longer than a specified time (where a door switch is used).

- The lights (when controlled by an output) could be switched Off when the unit is in Setback Mode.

5. Defrost control

The FreoCom is equipped with the facility to perform Timed and/or Active Defrost Function. This would simply disconnect the compressor (and other outputs if required) after a number of hours of compressor operation and/or when the evaporator temperature dropped down to defrost activation temperature.

For example, after 12 hours of accumulated operation of the compressor, the defrost cycle will be entered into for 45 minutes.

If an output is needed to come on during defrost, then this output would be energized during this time, making it ideal for controlling a reversing fan motor or a defrost heater.

For further information please refer to the comprehensive diagram found on the middle pages and to the Parameters Configuration section for full list of parameters that can be configured.

6. Voltage protection

The FreoCom continually senses the mains supply and will disconnect the compressor, Aux1 & Aux2 when the mains voltage is either higher or lower than acceptable limit. The FreoCom reconnects the mains voltage automatically after the supply returns and remains within normal limits (between High Voltage and Low Voltage reconnect voltages) for a pre-set time delay.

For further information please refer to the comprehensive diagram found on the middle pages and to the Parameters Configuration section for full list of parameters that can be configured.

7. Condenser temperature monitoring

When the second temperature probe is used to sense the condenser temperature, then the FreoCom will continuously monitor the condenser temperature. When this feature is enabled, then the FreoCom will switch Off the compressor and other outputs if needed when the condenser temperature

goes above the Condenser High Temperature, and stay in this situation until the condenser temperature drops below the Condenser Low Temperature.

8. Features

8.1 Temperature blind time

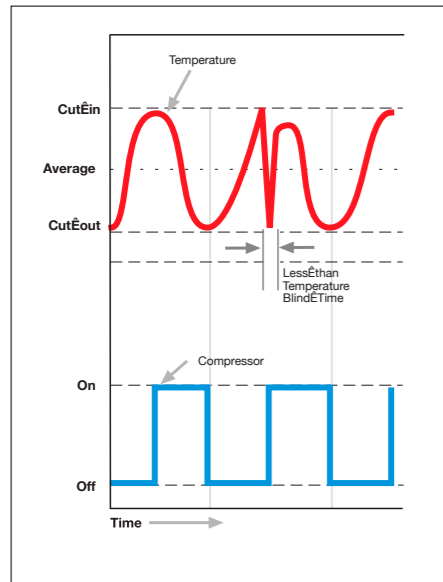

The software will ignore the sensor temperature reading for the first few seconds (a pre-set value of 10 seconds) after the compressor is switched on. This is to prevent short-term thermal effects such as those caused by the fan starting to operate causing disconnection.

8.2 High voltage and low voltage blind time

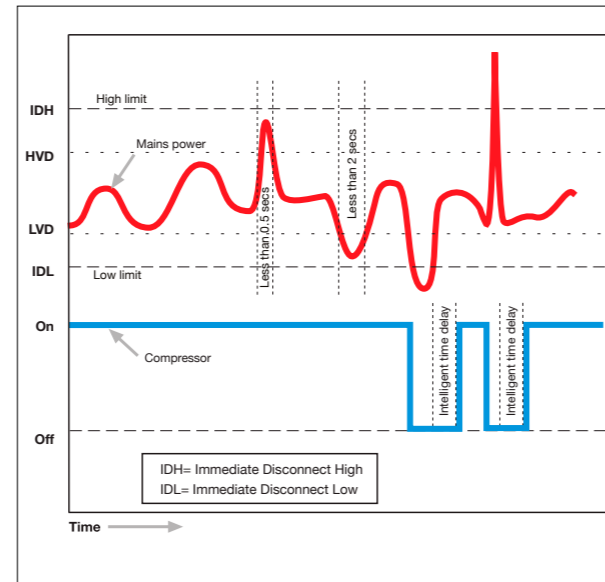

The software permits high and low mains voltages transitions for short periods of time preventing inadvertent compressor stop-starts. Preset values of 0.5 and 2 seconds respectively are employed. However, if the mains voltage goes higher or lower than set extreme limits, then the FreoCom will immediately disconnect the outputs. The low extreme limit is set at 75/83/150V, while the high extreme limit is set at 150/165/300V for 115/127/230V voltage systems.

8.3 Temperature dial 'Off' position



The control dial on the FreoCom can be set to an 'Off' position. This is achieved by turning the control dial fully anti-clockwise as shown above (dial marking 0 is to the left). This setting turns the compressor, Aux1 & Aux2 off regardless of temperature, allowing manual defrost, cleaning etc. The outputs are enabled when the dial position is changed.

8.4 Test mode

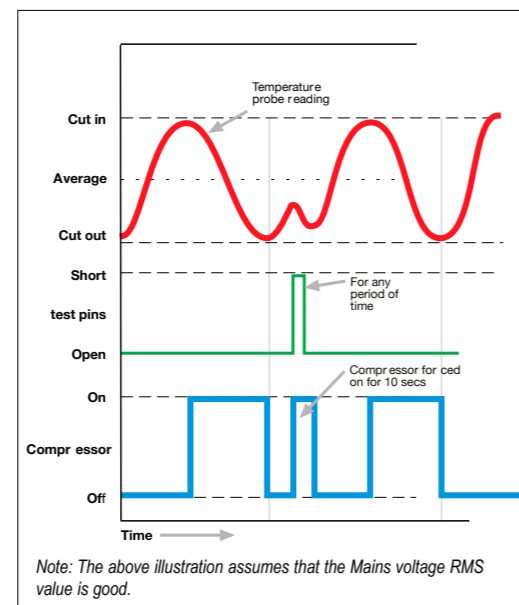

This is a useful feature during production or after sales service avoiding the necessity of bypassing the FreoCom. The test mode allows the technician to turn on the compressor for 10 seconds even though the cooler is at the required temperature. This is achieved by shorting the two test pins using a screwdriver or any other metallic object as shown.

small screwdriver or any metallic object

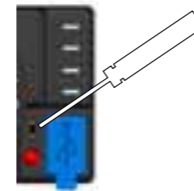

8. Features (continued)

8.5 Protection Time Delay

The FreoCom has a built-in protection time delay of up to 3 minutes (customer-specified).

The time delay is essential in allowing compressor gases to neutralise, ensuring that the mains has stabilised before re-connection and avoiding a locked rotor condition.

8.6 Re-Programmable

Please refer to section 14.

9. Alarms and errors

9.1 Frequency monitoring and error detection

The assumption is that cooling demand is on throughout the period

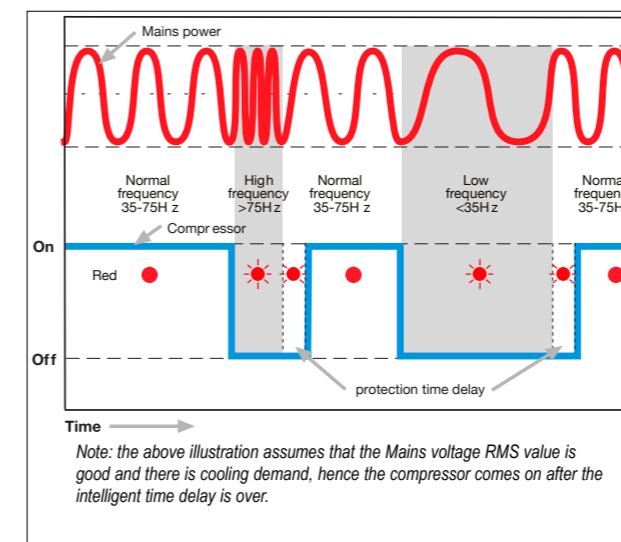

The FreoCom dynamically measures the frequency of the mains supply and reacts accordingly. If the mains supply frequency is too low or too high, the FreoCom will then disconnect the compressor, Aux1 & Aux2 and indicate an error signal through its indication LED.

The FreoCom has the ability to auto recover once the frequency is within acceptable limits. The built-in operational frequency range is 35-75Hz.

KEY	
●	Red LED is on
⚡	Red LED flashing very fast (0.5 Second ON/0.5 Second OFF)
⚡	Red LED flashing (1 Second ON/1 Second OFF)
⚡	Red LED flashing slowly (2 Seconds ON/2 Second OFF)
⚡	Red LED flashing very slowly (4 seconds ON/4 seconds OFF)

Note: the above illustration assumes that the Mains voltage RMS value is good and there is cooling demand, hence the compressor comes on after the intelligent time delay is over.

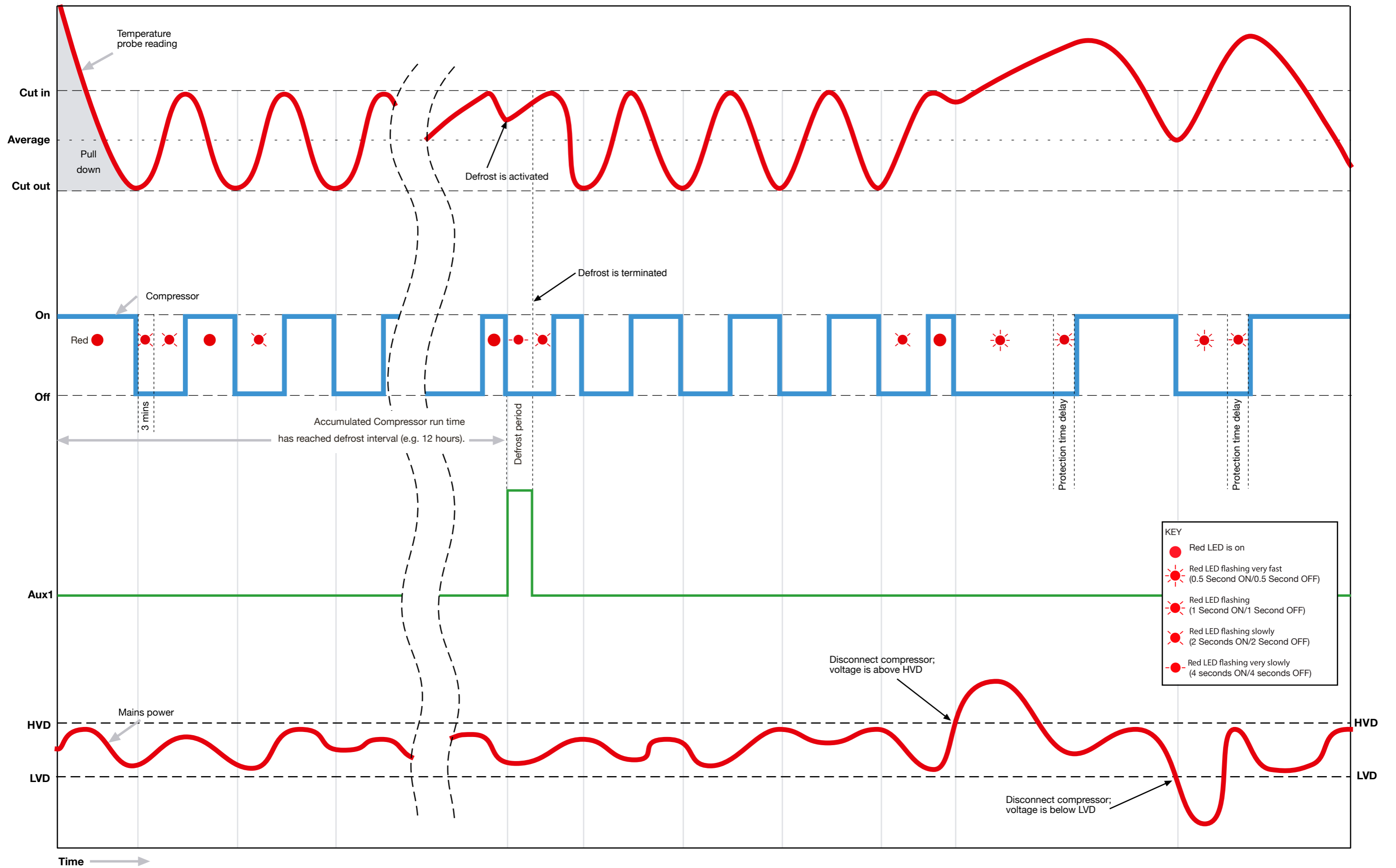

Note: For the above illustration, Aux1 is configured to come On during defrost (to run a defrost heater or a reverse fan for example), and Aux2 is not enabled.

9.2 Temperature probe error detection

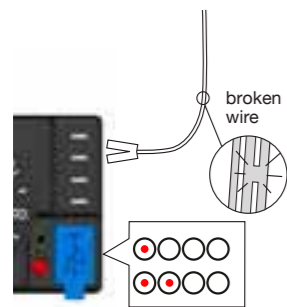

The FreoCom will report an error code through its indication LED indicating an external sensor fault if it happens. Depending on customer preference, the FreoCom will either:

1. Disconnect the load(s) and auto-recover once the problem clears; or
2. Cycle the compressor On and Off for pre-set periods regardless of the cooler temperature; or
3. Show the error signal through its indication LED.

The FreoCom recovers from this routine once the problem no longer exists. Refer to the Parameters Configuration section on how to configure various parameters.

Scenario: detect fault and disconnect

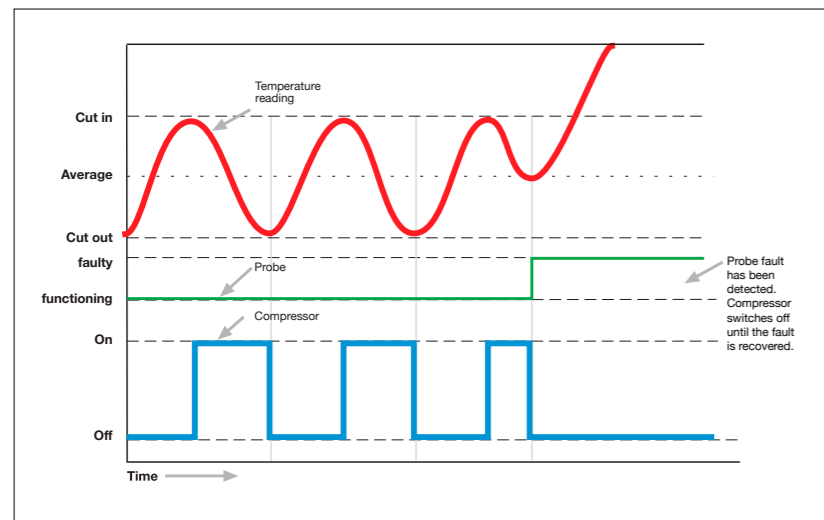

Scenario: detect fault and cycle

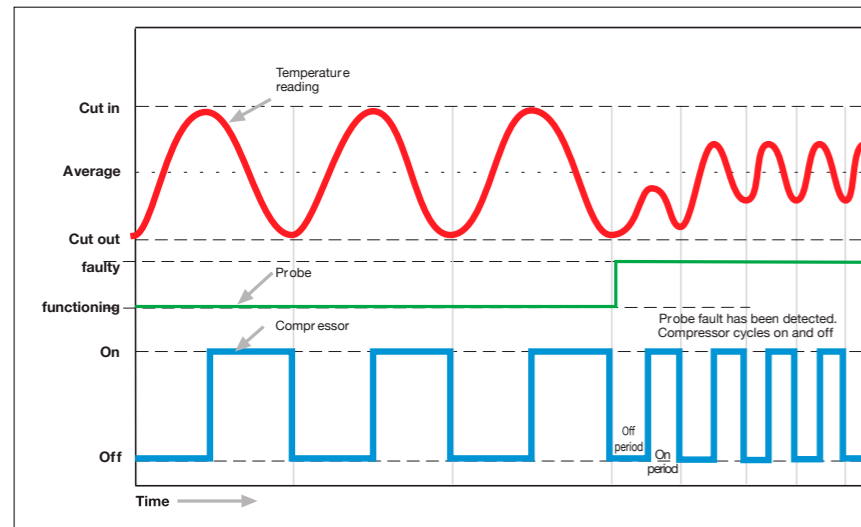

9.3 Internal fault detection

If an internal fault within the FreoCom is detected and reported through its indication LED, then the most likely action would be to replace the unit. In some instances, the fault may automatically clear and the FreoCom auto-recovers and returns to normal run mode.

The FreoCom is fully encapsulated, designed mainly for OEM (Original Equipment Manufacturer) applications and rated at 16Amps. These devices are encapsulated to hermetically seal and ruggedise them. Vertical fast-on terminals are used for power connections and 0.11" vertical fast-on terminals are used for probes and door switch connections. All these terminals are suitable for push-on crimps.

Connections to the FreoCom

- Mains power (or utility power) connections are made using standard 0.25" vertical crimp terminals marked Neutral, Live in, Comp, Aux1 & Aux2.
- Mains Live and Neutral should be connected to Live in and Neutral terminals respectively.
- The compressor live should be connected to Comp terminal.
- Other live connections should be connected to the Aux1 & Aux2 terminals. Aux1 & Aux2 are suitable to drive an evaporator fan, reverse fan, defrost heater, lights or any other customer's specific application.
- Connect the regulation temperature probe to the FreoCom crimp terminals labeled PRB1. Depending on the cooler manufacturer, the regulation temperature probe could be mounted either inside the evaporator or within the cooler cabinet, in the airflow from the cabinet into the evaporator, to ensure the probe measures the temperature of the airflow over the product.
- Connect the second temperature probe (if used) to the FreoCom crimp terminals labeled PRB2. This could be used either for defrost temperature sensing or condenser temperature monitoring. If a door switch is required, then the door switch needs to be connected to PRB2 terminals and only one temperature probe can be used with the FreoCom.
- On first switching on there will be no output for the duration of the wait time. As the FreoCom has protection delay time, it will re-connect the power once the protection delay is over. The FreoCom unit will start working normally based on the configurations it's programmed with and the indication LED will light as shown in section 2.2 (LED description).

Testing Procedure

This is a simple procedure to individually test the main three functions of the unit, which are Thermostatic Control, Defrost Control and Voltage Protection.

Refer to the unit's configuration for exact list of parameters settings.

A) To test the Thermostatic function.

1. Install the FreoCom in the cooler as described above. Adjust the temperature setting dial so that marking "12" is pointing to the left (when power terminals are on the left). Connect the cooler to a source of variable AC voltage such as a Variac. Adjust the output of the Variac to a good starting voltage (within the acceptable limits). The Red LED will be flashing at a rate of 2 seconds ON/2 second OFF if the temperature sensed by the regulation temperature probe is below cut-in value or at a rate of 1 second ON/1 second OFF if the temperature is above cut-in value.

2. When the Protection Time Delay is over, the FreoCom will connect the mains supply to the compressor (assuming

the temperature sensed by Probe #1 is above cut-in temperature). (TIP ** The FreoCom has two special test pins. By shorting these pins with a conducting object, the Protection Time Delay is bypassed and the FreoCom will energise immediately.

3. Once the cabinet has reached the desired temperature (the temperature sensed by Probe #1 drops below cut-out temperature), the FreoCom will disconnect the compressor and the Red LED will be flashing at a rate of 2 seconds ON/2 seconds OFF (which indicates incoming voltage is good and compressor satisfied).
4. If the Voltage Protection feature is enabled and if the incoming voltage drops below the acceptable low level, the FreoCom will now move to flashing the red LED at a faster rate - 0.5 seconds ON/0.5 seconds OFF (which indicates incoming voltage is BAD).

B) To test the defrost function (if enabled) – ensure that the incoming voltage is within the acceptable limits.

Note: This test may take a long time to wait for either the defrost start time to be over or for the evaporator temperature to drop below the defrost start temperature.

1. Install the FreoCom in the cooler as described above. Connect the cooler to a source of variable AC voltage such as a Variac. Adjust the output of the Variac to a good starting voltage (within the acceptable limits). The compressor and the Red LED should come ON after the protection time delay (or by shorting out the two test pins), assuming that the temperature is above cut-in value.
2. The unit will go to defrost as soon as the defrost start criteria is met. This could be either defrost start time is over or the evaporator temperature drops below defrost start temperature value, whichever happens first and depending which ones are activated.
3. Once the unit is in defrost, the compressor will be OFF and the Red LED will be flashing at a rate of 4 seconds ON/4 seconds OFF.
4. If Aux1 & Aux2 are configured to be ON during defrost, then this output should be ON during this time.
5. The unit will stay in defrost until the defrost end criteria is met. This could be either defrost end duration is over or the evaporator temperature has risen above defrost end temperature value, whichever happens first and depending on which ones are activated.

C) To test the voltage function (if enabled) - first ensure that the thermostat dial on the FreoCom is set so that marking "12" is pointing to the left (when power terminals are on the left)

1. Connect the FreoCom to a variable power source (e.g. Variac) and ensure the output of the Variac is at a good starting

10. Installation Guide (continued)

voltage (i.e. between 110-115V or 220-230V). The Red LED will be flashing at rate of 1 second ON/1 second OFF for the duration of the protection time delay (assuming the temperature is above cut-in value)

- When the Protection Time Delay, the FreoCom will energize the load(s) and the Red LED is now on. (TIP ** The FreoCom has two special test pins. By shorting these pins with a conducting object, the 3-minute delay is bypassed and the FreoCom will energise immediately.)
- Slowly decrease the voltage until the Red LED momentarily switches OFF. The Red LED will stay OFF for the duration of the Under Voltage Blind Time, then the FreoCom will disconnect the outputs and the Red LED starts flashing fast at a rate of 0.5 seconds ON/0.5 seconds OFF. This represents the Low Voltage Disconnect voltage.
- Increase the voltage slowly until the Red LED starts flashing at a slower rate (1 second ON/1 second OFF). This represents the Low Voltage Reconnect voltage. Wait for the Protection Time Delay, then the Red LED will be solid ON.
- Repeat the above process for the over-voltage. The voltage at which the Red LED starts flashing fast (0.5 seconds ON/0.5 seconds OFF) and the outputs switch off represents the High Voltage Disconnect voltage.
- To check the over-voltage reconnect, drop the voltage until the Red LED starts flashing at a slower rate (1 second ON/1 second OFF). This represents the High Voltage Reconnect voltage.

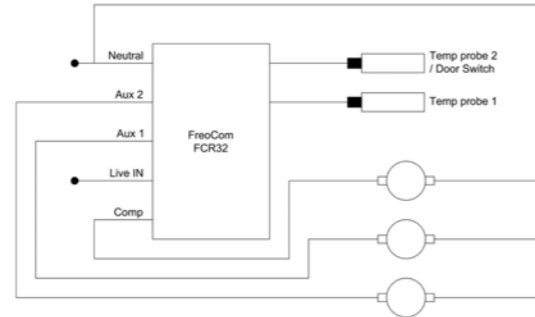

11. Mechanical drawings

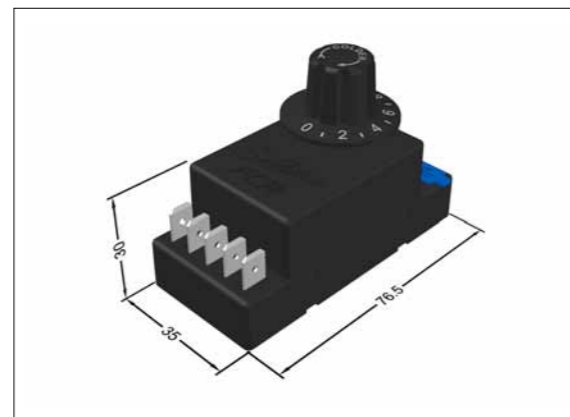
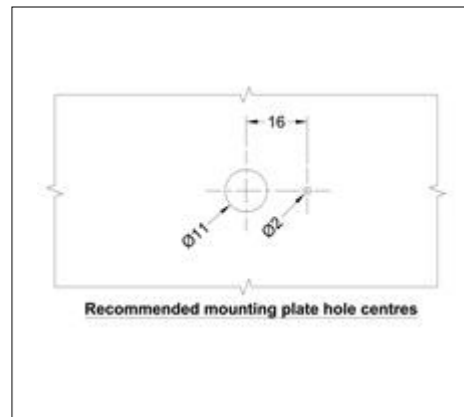

12. Specifications

Control	Microprocessor
Temperature control	Yes, programmable
Energy saving	Yes
Defrost control	Active or timed
Voltage protection	Yes, HVD and LVD with programmable parameters
Operational voltage range	90 - 150V or 180 - 300V
Inputs	2 temperature probes or 1 temperature probe plus door switch
Output - compressor	16A 250VAC 70A Inrush current @240VAC 140A Inrush current @120VAC 0.75HP @ 120VAC 1.5HP @ 240VAC 4000 VA breaking capacity
Output - Aux1 & Aux2	3A 250VAC 40A Inrush current @240VAC 80A Inrush current @120VAC 0.125HP @ 120VAC 0.25HP @ 240VAC 1500 VA breaking capacity
Working frequency	Auto-sense 50/60Hz
Surge protection	6.5kA
Compressor protection	Voltage protection and de-compression delay
Reprogrammable	Yes, via Sollatek SPP programming system.
Configurable	Yes, fully configurable based on the customer's needs via Sollatek SPP programming system.
Remote connections	Temperature probes and door switch
Power connections	Fast-on terminals suitable for push-on crimps
Environmental	Sealed and protected against water, humidity, dust and insects
Unit dimensions (mm)	76.5 x 30 x 35
Unit weight (g)	80
Temperature probe type	Probe (NTC)
Temperature probe dimensions	Available in various lengths and diameters. Refer to Sollatek Temperature Probe datasheet for more information.

Note: All the mentioned values throughout sections 3 to 7 can be customer specified.

13. Parameters Configuration

Using Sollatek FCR Configuration Interface software, the customers have the ability to configure various parameters based on their requirements and needs. The full set of parameters to configure are listed here:

Item	Unit	Data Range	Variable	Meaning/Comments
Hardware Configuration				
Number of Outputs	Number	1, 2 or 3		FCRy -> x = Number of Outputs, y = Number of Temperature Probes The number of available outputs
Number of Temperature Probes	Number	1 or 2		The number of available temperature probes
Enable Door Switch		Yes or No		Enabling/Disabling the detection of the door switch operation. If enabled, the 2nd probe input will be used for door switch operation
Relay#2 Configuration				
Relay#2 is only available when the "Number of Outputs" is set to 2 or 3 (FCR2y or FCR3y)				
Operation When Compressor is Cycling On		On/Off/Cycling/Heater		Relay#2 operation when compressor is On, for "Heater" setting, please refer to "Heater Function" section below
Cycling On Time (mins)	Mins	1 to 255		On duration in minutes when Relay#2 is set to cycle
Cycling Off Time (mins)	Mins	1 to 255		Off duration in minutes when Relay#2 is set to cycle
Operation When Compressor is Cycling Off		On/Off/Cycling/Heater		Relay#2 operation when compressor is Off, for "Heater" setting, please refer to "Heater Function" section below
Cycling On Time (mins)	Mins	1 to 255		On duration in minutes when Relay#2 is set to cycle
Cycling Off Time (mins)	Mins	1 to 255		Off duration in minutes when Relay#2 is set to cycle
Operation During Defrost		On/Off/Cycling/Heater		Relay#2 operation during defrost, for "Heater" setting, please refer to "Heater Function" section below
Cycling On Time (mins)	Mins	1 to 255		On duration in minutes when Relay#2 is set to cycle
Cycling Off Time (mins)	Mins	1 to 255		Off duration in minutes when Relay#2 is set to cycle
Operation When Probe#1 is Faulty				
Cycling On Time (mins)	Mins			
Cycling Off Time (mins)	Mins			
Operation When Probe#2 is Faulty				
Cycling On Time (mins)	Mins			
Cycling Off Time (mins)	Mins			
Operation When Door Switch is Open		Normal/Off		When the door switch is open, Relay#2 could either continue to run normally or it will switch Off after some optional delay
Door Switch Open Persistence Duration (secs)	Secs	N/A or 1 to 255		Delay of the door switch being open until Relay#2 switches Off
Door Switch Close Persistence Duration (secs)	Secs	N/A or 1 to 255		Delay of the door switch being closed until Relay#2 starts running normally
Relay#3 Configuration				
Relay#3 is only available when the "Number of Outputs" is set to 3 (FCR3y)				
Operation When Compressor is Cycling On		On/Off/Cycling/Heater		Relay#3 operation when compressor is On, for "Heater" setting, please refer to "Heater Function" section below
Cycling On Time (mins)	Mins	1 to 255		On duration in minutes when Relay#3 is set to cycle
Cycling Off Time (mins)	Mins	1 to 255		Off duration in minutes when Relay#3 is set to cycle
Operation When Compressor is Cycling Off		On/Off/Cycling/Heater		Relay#3 operation when compressor is Off, for "Heater" setting, please refer to "Heater Function" section below
Cycling On Time (mins)	Mins	1 to 255		On duration in minutes when Relay#3 is set to cycle
Cycling Off Time (mins)	Mins	1 to 255		Off duration in minutes when Relay#3 is set to cycle
Operation During Defrost		On/Off/Cycling/Heater		Relay#3 operation during defrost, for "Heater" setting, please refer to "Heater Function" section below
Cycling On Time (mins)	Mins	1 to 255		On duration in minutes when Relay#3 is set to cycle
Cycling Off Time (mins)	Mins	1 to 255		Off duration in minutes when Relay#3 is set to cycle
Operation When Probe#1 is Faulty				
Cycling On Time (mins)	Mins			
Cycling Off Time (mins)	Mins			
Operation When Probe#2 is Faulty				
Cycling On Time (mins)	Mins			
Cycling Off Time (mins)	Mins			
Operation When Door Switch is Open		Normal/Off		When the door switch is open, Relay#3 could either continue to run normally or it will switch Off after some optional delay
Door Switch Open Persistence Duration (secs)	Secs	N/A or 1 to 255		Delay of the door switch being open until Relay#3 switches Off
Door Switch Close Persistence Duration (secs)	Secs	N/A or 1 to 255		Delay of the door switch being closed until Relay#3 starts running normally
Temperature Control				
Temperature Blind Time (secs)	Secs	0 to 25		Time during which the unit will ignore the reading of the temperature probe after the compressor has just switched On
Temperature Regulation Temperature Probe		Probe#1/Probe#2		Select either Probe#1 or Probe#2 to be used to regulate the cooler temperature
Temperature Unit		"C"/"F"		Selecting the unit to display the temperature values
Temperature Dial Type		Linear/Discrete		The front potentiometer (marked 0 to 9) is used to change the unit temperature settings Linear = The temperature range is continuous even when the pot is set between two marks Discrete = If pot is set between two marks, the setting value of the closer mark will be used
Enable Control Dial Off Position (Marking#0 & 1)		Yes/No		When it's enabled, all outputs will switch Off when the control dial is set to marking#0
Marking#0 Cut-In Temp		-28.0°C to 25.0°C or -18.4°F to 77.0°F		
Marking#1 Cut-In Temp		-28.0°C to 25.0°C or -18.4°F to 77.0°F		
Marking#2 Cut-In Temp		-28.0°C to 25.0°C or -18.4°F to 77.0°F		
Marking#3 Cut-In Temp		-28.0°C to 25.0°C or -18.4°F to 77.0°F		
Marking#4 Cut-In Temp		-28.0°C to 25.0°C or -18.4°F to 77.0°F		
Marking#5 Cut-In Temp		-28.0°C to 25.0°C or -18.4°F to 77.0°F		
Marking#6 Cut-In Temp		-28.0°C to 25.0°C or -18.4°F to 77.0°F		
Marking#7 Cut-In Temp		-28.0°C to 25.0°C or -18.4°F to 77.0°F		
Marking#8 Cut-In Temp		-28.0°C to 25.0°C or -18.4°F to 77.0°F		
Marking#9 Cut-In Temp		-28.0°C to 25.0°C or -18.4°F to 77.0°F		
Marking#10 Cut-In Temp		-28.0°C to 25.0°C or -18.4°F to 77.0°F		
Marking#11 Cut-In Temp		-28.0°C to 25.0°C or -18.4°F to 77.0°F		
Marking#12 Cut-In Temp		-28.0°C to 25.0°C or -18.4°F to 77.0°F		
Marking#0 Cut-Out Temp		-28.0°C to 25.0°C or -18.4°F to 77.0°F		
Marking#1 Cut-Out Temp		-28.0°C to 25.0°C or -18.4°F to 77.0°F		
Marking#2 Cut-Out Temp		-28.0°C to 25.0°C or -18.4°F to 77.0°F		
Marking#3 Cut-Out Temp		-28.0°C to 25.0°C or -18.4°F to 77.0°F		
Marking#4 Cut-Out Temp		-28.0°C to 25.0°C or -18.4°F to 77.0°F		
Marking#5 Cut-Out Temp		-28.0°C to 25.0°C or -18.4°F to 77.0°F		
Marking#6 Cut-Out Temp		-28.0°C to 25.0°C or -18.4°F to 77.0°F		
Marking#7 Cut-Out Temp		-28.0°C to 25.0°C or -18.4°F to 77.0°F		
Marking#8 Cut-Out Temp		-28.0°C to 25.0°C or -18.4°F to 77.0°F		
Marking#9 Cut-Out Temp		-28.0°C to 25.0°C or -18.4°F to 77.0°F		
Marking#10 Cut-Out Temp		-28.0°C to 25.0°C or -18.4°F to 77.0°F		
Marking#11 Cut-Out Temp		-28.0°C to 25.0°C or -18.4°F to 77.0°F		
Marking#12 Cut-Out Temp		-28.0°C to 25.0°C or -18.4°F to 77.0°F		
Delays and Timers				
Compressor Relay Off Protection Delay (secs)	Secs	0 to 500		This is the minimum time for the compressor to stay Off after it has been switched Off
Delay Between Loads	Secs			
Defrost Function				
Enable Defrost Function		Yes/No		Enabling/Disabling the defrost function
Defrost Temperature probe		N/A or Probe#1 or Probe#2		
Inhibit Defrost Until First Pull-down Event		Yes/No		If enabled, the defrost cycle will not take place until the first pull-down is over (the first time compressor cycles Off after power up due to the temperature dropping below cut-out value)
Inhibit Defrost Temperature	"C" or "F"	N/A or 0°C to 25.0°C or 32°F to 77.0°F		If enabled, this represents the startup temperature (set by the regulation temperature probe) above which the defrost will be inhibited during first pull-down
Defrost Inhibit Duration (hours)	Hours	N/A or 1 to 255		If enabled, this item represent the maximum duration during first pull-down where defrost will be inhibited
Defrost Enable Temperature		Yes/No		If enabled, defrost will be disabled when the temperature sensed by the regulation temperature probe is higher than a certain value, current cut-in value.
Absolute Temperature	"C" or "F"	-28.0°C to 25.0°C or -18.4°F to 77.0°F		The value could be either an absolute value or a certain offset above the
Degrees Above Cut-In	"C" or "F"	0°C to 20°C or 0°F to 36°F		
Type of Defrost Start Time		Real/Accumulated/Continuous		Real = Defrost will start when the time since last defrost cycle (or start up) has reach the assigned value, regardless of the compressor cycling Accumulated = Defrost will start when the accumulated compressor On times has reach the assigned value Continuous = Defrost will start only the compressor has been running continuously with no interruption for the assigned duration
Defrost Start Time (hours)	Hours	N/A or 1 to 255		This will determine when the defrost cycle will be initiated, depending on the "Type of Defrost Start Time" setting
Defrost Duration (mins)	Mins	N/A or 1 to 255		The duration the unit will stay in defrost (until it is terminated by temperature or other feature)
Minimum Defrost Duration (mins)	Mins	N/A or 1 to 255		Once defrost cycle starts, the unit stays in defrost for at least this duration even though the defrost was to terminate due to temperature or other feature
Minimum Duration Between Defrost Cycles (hours)	Hours	N/A or 1 to 255		Defrost cycle will not initiate unless the unit hasn't been in defrost for at least this duration even though if defrost is to start due to temperature or other feature
Defrost Start Temperature	"C" or "F"	N/A or -28.0°C to 25.0°C or -18.4°F to 77.0°F		Defrost cycle will start when the temperature drops below this assigned value, assuming defrost is not disabled by any of the other features
Defrost End Temperature	"C" or "F"	N/A or -28.0°C to 25.0°C or -18.4°F to 77.0°F		Defrost will terminate when the temperature rises above this assigned value, assuming it's been in defrost for longer than the value of "Minimum Defrost Duration (mins)"
Enable Temperature Defrost During First Pull-down				
Enable Defrost Emergency Mode		Yes/No		If enabled, then the unit will revert to a pre-set defrost cycle durations when the defrost temperature probe is faulty
Emergency Mode Defrost Start Time (hours)	Hours	1 to 255		When the unit is in Defrost Emergency Mode, this parameter determines how often the unit will start a defrost cycle
Emergency Mode Defrost End Time (mins)	Mins	1 to 255		When the unit is in Defrost Emergency Mode, this parameter determines the defrost duration
Enable Defrost When Probe#1 is Faulty		Yes/No		If enabled, then the unit will continue to go into defrost even though Probe#1 is faulty
Enable Defrost When Probe#2 is Faulty		Yes/No		If enabled, then the unit will continue to go into defrost even though Probe#2 is faulty
Voltage Protection				
Enable Voltage Protection		Yes/No		Enabling/Disabling the voltage protection feature
Nominal Voltage (Vac)	Vac	115 or 230		
High Voltage Disconnect (Vac)	Vac	75 to 150 or 150 to 300		The unit will switch Off all outputs when the voltage is above this assigned value
High Voltage Reconnect (Vac)	Vac	75 to 150 or 150 to 300		The unit will allow switching the outputs On when the voltage is below this assigned value
Low Voltage Disconnect (Vac)	Vac	75 to 150 or 150 to 300		The unit will switch Off all outputs when the voltage is below this assigned value
Low Voltage Reconnect (Vac)	Vac	75 to 150 or 150 to 300		The unit will allow switching the outputs On when the voltage is above this assigned value
High Voltage Blind Time (secs)	Secs	0 to 25		Period during which high voltage is detected but ignored
Low Voltage Blind Time (secs)	Secs	0 to 25		Period during which low voltage is detected but ignored
Door Switch Operation				
Operation When Door Switch is Open		Normal/Off		When the door switch is open, the compressor could either continue to run normally or it will switch Off after some optional delay
Door Switch Open Persistence Duration (secs)	Secs	N/A or 1 to 255		Delay of the door switch being open until the compressor switches Off
Door Switch Close Persistence Duration (secs)	Secs	N/A or 1 to 255		Delay of the door switch being closed until the compressor starts running normally
Heater Function				
Heater Cut-In Temperature		-28.0°C to 25.0°C or -18.4°F to 77.0°F		When Relay#2 or 3 are configured to run a heater, then heater will come On when the temperature drops below heater cut-in temperature
Heater Cut-Out Temperature		-28.0°C to 25.0°C or -18.4°F to 77.0°F		When Relay#2 or 3 are configured to run a heater, then heater will switch Off when the temperature rises above heater cut-out temperature
Other Auxiliary Always On When Heater is On				
Probe#1 Fault Detection				
Enable Faulty Temperature Probe Detection		Yes/No		Enabling/Disabling the detection of a faulty temperature probe
Type Of Fault Detection		Active/Passive		Active = the unit will operate the outputs(s) in a special way, Passive = the unit will give out LEDs indication only
Probe Active Fault Detection		Compressor Off/Compressor Cycle		Compressor Off = Compressor will be Off all the time, Compressor Cycle = Compressor will cycle On/Off to maintain cold beverage
Compressor Cycling On Time (mins)	Mins	1 to 255		On duration in minutes when Compressor is set to cycle
Compressor Cycling Off Time (mins)	Mins	1 to 255		Off duration in minutes when Compressor is set to cycle
Probe#2 Fault Detection				
Enable Faulty Temperature Probe Detection		Yes/No		Enabling/Disabling the detection of a faulty temperature probe
Type Of Fault Detection		Active/Passive		Active = the unit will operate the outputs(s) in a special way, Passive = the unit will give out LEDs indication only
Probe Active Fault Detection		Compressor Off/Compressor Cycle		Compressor Off = Compressor will be Off all the time, Compressor Cycle = Compressor will cycle On/Off to maintain cold beverage
Compressor Cycling On Time (mins)	Mins	1 to 255		On duration in minutes when Compressor is set to cycle
Compressor Cycling Off Time (mins)	Mins	1 to 255		Off duration in minutes when Compressor is set to cycle

14. Freo device programming guide

The FCR unit can be programmed using any of the following solutions. The customer is able to program the FCR with any required set of specifications/parameters. Refer to section (Parameters Configuration) for full list of parameters that can be configured.

14.a – Using Sollatek SPP02 Programmer

Under development.

14.b – Using ST-Link Programmer

A Freo device uses an ST Microelectronics micro controller, so to upgrade the firmware the ST programming tools must first be downloaded from the links below. Choose the correct driver for your PC operating system, install it, and then install the STVP application.

Look for the red 'download' button near the bottom of the web page.

Software Requirements

Programmer Drivers

ST-LINK USB drivers for Windows XP to 7 <http://www.st.com/web/en/catalog/tools/PF258167#>

'OR'

ST-LINK USB drivers for Windows 8 <http://www.st.com/web/en/catalog/tools/PF259459>

Programming Application

STVP Application <http://www.st.com/web/en/catalog/tools/PF210568>

Parameters Configuration Application

Freo Configuration Interface <https://www.dropbox.com/sh/wzvzipqs84r99j4/AABenKOJRrEaYxrkjfmEQ8Ta?n=69954778>

Hardware Requirements

- ST-LINK/V2 programmer labelled with "Vdd powered from USB".
- 1 off USB cable to connect the programmer to the PC (provided).
- 1 off Sollatek Programming Micro USB cable to connect the programmer to the FCR unit (provided).

Changing Parameters and Generating New Firmware

Sollatek Freo Configurator Interface application has been created to allow a user to easily change Freo device parameters and upload them to the Freo controller. This app can be downloaded from the link provided above.

(Note that the dotNetFx40 file needs to be installed on systems older than windows 7 that do not have it. If during installation it asks to modify or remove software, please press cancel as it is already installed).

1. Install the 'Freo Configurator' software. Enter a username and password to continue. (Please contact Sollatek if you have not received a username and password). A new icon should appear on the desktop, double-click this icon to run the app.



2. Go to FILE > NEW to open a parameters form. (Open to open a previously saved file)

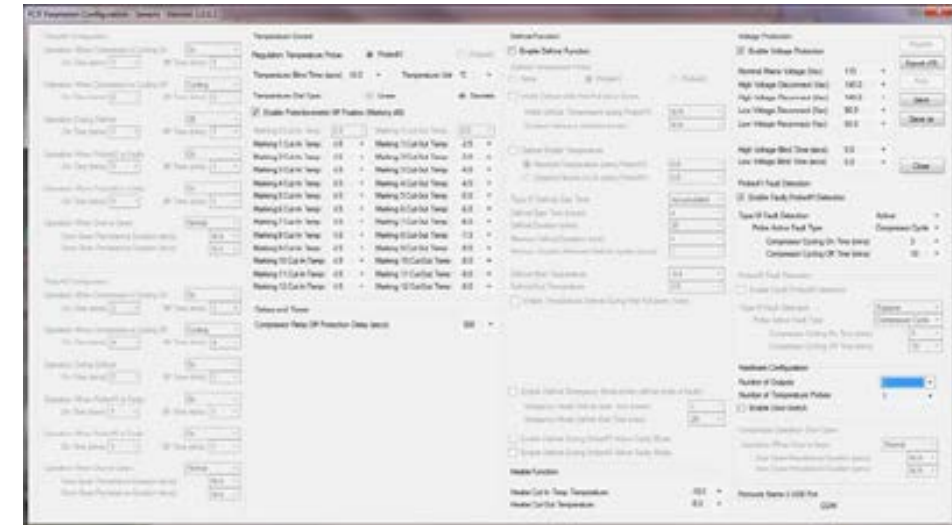

3. Adjust the parameters on the form to suit your application. Start by setting the hardware parameters in the bottom-right of the form.
4. When finished changing the parameters please save the file and click on "Export s19" button to generate the ".s19" file that will be used by the STVP to reprogram the Freo device.

Setting up the Programmer

1. **ENSURE THE FREO DEVICE IS ISOLATED FROM POWER.**
2. Connect a ST-LINK/V2 to the PC via the provided USB cable, and connect the ST-LINK/V2 to the FCR through the provided micro USB cable.
3. Run the STVP application downloaded above.

Programming Procedure

1. With the STVP application running, go to PROJECT > OPEN.
2. Find the ".stp" file generated by the Freo Configurator Interface and open it. This will load the data needed by the Freo device into STVP.
3. On the STVP, click on "Program all tabs" button, as pointed out below.
4. A warning may appear about the memory read out protection, click YES to continue.
5. Wait for programming and verification to complete successfully. Message "OPTION BYTE successfully verified" should appear at the bottom of the STVP status window.
6. Disconnect the Freo device from the programmer. This concludes successful programming.

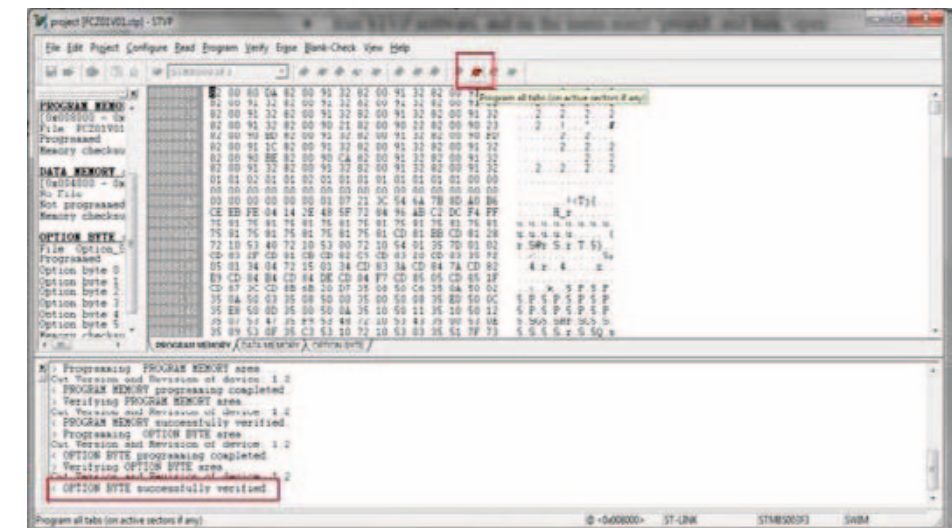

Revision History

Version	Date	Edited	Description
Ver1.01	11/06/2014	DJL	First Issue of Freo device programming guide
Ver1.02	11/07/2014	AER	Second Issue, added updated programming interface image



SOLLATEK (UK) LTD

UNIT 9/10 NEWLANDS DRIVE,
POYLE 14 INDUSTRIAL ESTATE, COLNBROOK,
SLOUGH, BERKSHIRE SL3 0DX,
UNITED KINGDOM

Tel: International +44 1753 688300 National 01753 688300

Fax: International +44 1753 685306 National 01753 685306

Technical help: support@sollatek.com

E-mail: sales@sollatek.com

www.sollatek.com

©Sollatek (UK) Limited 2010 All Rights Reserved.
SOLLATEK and the SOLLATEK device are the trade marks of the
Sollatek group of companies.