

iVOLT[®]

Intelligent Power Optimisation

The control panel is divided into three columns for Phase 1, Phase 2, and Phase 3. Each column contains three digital displays. The top display in each column is labeled 'INPUT VOLTAGE', the middle one 'OPTIMIZED VOLTAGE', and the bottom one 'OUTPUT CURRENT'. The iVOLT logo is printed at the bottom left of the panel.

iVOLT



2



Seamless bypass arrangement. Fully integrated low voltage panel with three phase 2,400Amps / 1,584kVA



iVolt optimising the power at Leicester station

RAILWAYS

“The station is in operation 24/7 and consumes a large amount of electricity so it is imperative that we reduce our running costs, not only using the iVolt but with other controlling systems. Our main areas of consumption are platform lighting and office heating. There are days when lights are on for long periods of time and the voltage would be high and by installing the iVolt and reducing the consumption we expect to reduce our running costs and carbon footprint. A couple of years ago we experienced a high surge of power at one of our stations, which caused unnecessary damage which may have been prevented if the iVolt had been installed.”

**Robbie Moir, Estates Maintenance Manager,
East Midlands Trains**





FACT

No other company can measure
actual savings in real time ...



What is Voltage Optimisation?

Voltage levels provided by power companies in the UK and other countries are not typically matched to the optimum level for most electrical equipment. Voltage Optimisation is a method of reducing mains voltage to save energy, reduce costs and maximise equipment efficiency. Using Voltage Optimisation with electrical equipment such as refrigeration or air cooling devices, 3-phase motors, high-intensity discharge or fluorescent lighting, will reduce energy consumption and create real financial savings. Voltage Optimisation also increases the service life of electrical equipment by running at the lower voltages that the equipment was designed to run at.

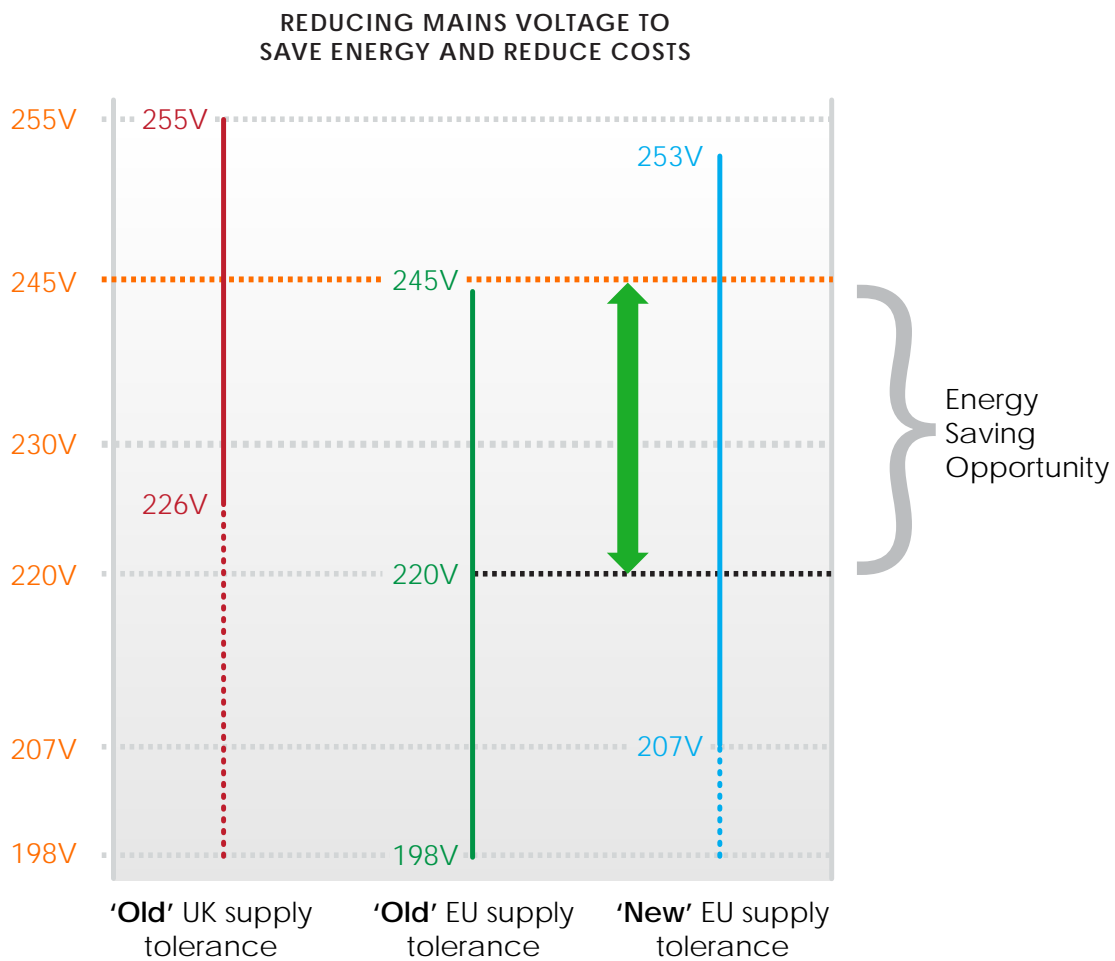

In Europe, generating companies are required to provide customers with a voltage between 207V and 253V. The average voltage across the UK is 245V, but levels can fluctuate significantly throughout the day on each site. Across Europe, the standard voltage has been historically 220V.

As a result, most electrical equipment is designed and specified to operate most effectively and efficiently at 220V. Providing equipment with higher voltages actually reduces efficiency and leads to wasted energy.

How iVolt® saves you more

Voltage Optimisation can be achieved with typically traditional fixed step-down transformers or variable voltage regulators/stabilisers.

Depending on site characteristics, step-down transformers are installed to reduce the voltage by a fixed percentage ranging from 4% to 8%.

The iVolt® is an award winning innovative variable voltage regulator/stabiliser that automatically adjusts the incoming voltage to ensure that the output voltage is always constant at 220V ± 1.5%. The iVolt® will deliver a voltage reduction of up to 12% whenever possible.

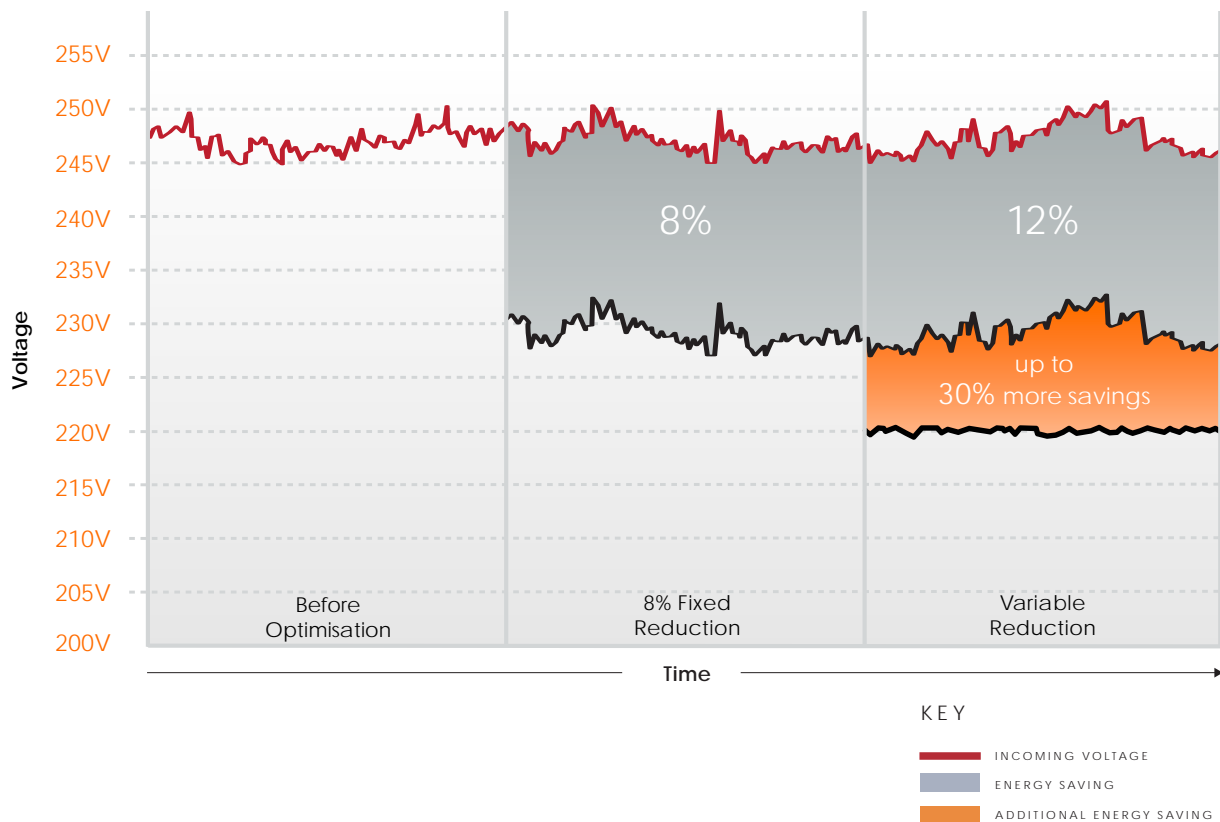

EDUCATION

“Grahame Duguid, described the savings as “very pleasing” and praised iVolt for the “seamless” installation process. “There were no issues. It is very important to have good suppliers that get things right the first time and I can definitely say that was the case with iVolt.”



Grahame Duguid, Controls & Energy Manager for Amey Built Environment's Education Scotland



iVolt® features and benefits

Features	Benefits
Unique IRT Energy Monitor® technology (patent pending) with cloud based portal (optional)	Measures and reports actual energy savings accurately Analytical tool for energy and engineering managers. Day by day analysis of savings, consumption and power
Stabilisation over wide voltage range up to 12% reduction	Maximises energy and cost savings when incoming voltage is high
Maintains stable voltage even if site voltage drops to 220V	Eliminates risk of "brown outs" and equipment failure when fixed tap systems are set too low.
Active voltage stabilisation at $\pm 1.5\%$ of 220V	Over 90% of UK sites would save more energy with an iVolt® compared to leading fixed reduction systems
Independent 3 phase control	Active phase balancing, improved power quality to enhance equipment life
Solid state thyristor technology using zero volt switching	No moving parts in the power circuits, no annual maintenance required and no 'chopping' of the waveform
In-built electronic failsafe mode design with automatic integral bypass	Maintains continuity of supply to site
Removal of voltage spikes and surges	Added protection for site equipment and improved power quality
Manufactured with low loss component technology	The iVolt® is over 99.4% efficient at full load and maximises energy savings
Reliable and proven technology built in ISO9001 accredited facilities	All iVolt® units have a 15 year guarantee and are manufactured to relevant BS Standards. Over 440,000 units manufactured since 1987
RS485 and USB data communications	Fully integrable into building management software systems
USB port on main unit for data download	Ease of data extraction

FOOD MANUFACTURING

“The iVolt looks like a win win for us as early indications show our savings to be in excess of 10% which means it will have paid for itself in three years.”

Andy Bowers, Operations Manager,
Imagefarm



Voltage optimisation comparisons:

	Fixed step-down transformers	Mechanical servo systems	iVolt®	iVolt® benefits
12% voltage reduction through electronic tap settings	No*	Yes	Yes	Greater savings and faster project ROI. Able to reduce incoming voltage from 253V to a stable 220V
Microprocessor controlled	No	Sometimes	Yes	Improves stability of voltage
Maintenance-free	Yes	No	Yes	No ongoing maintenance costs
No moving mechanical parts	Yes	No	Yes	Less maintenance and risk of failure
Reduces risk of undervoltage	No	Yes	Yes	Protects equipment against damaging voltage dips (brown outs)
Compensates for fluctuations	No	Yes	Yes	Creates a more stable voltage and maximises savings
Improves power quality	Yes	Yes	Yes	Reduced maintenance costs on electrical equipment
Integrated IRT Energy Monitor®	No	No	Yes	Real-time measurement and reporting of energy saving
Remote monitoring through web portal	No	No	Yes	Provides detailed site analysis on savings, consumption and power
Data alerts by SMS/Email	No	No	Yes	Immediate event notification
Output voltage accuracy (+/-)	8%	0.5 to 2%	1.5%	Increased voltage stability
Remote adjustable output voltage	No	Yes	Yes	Flexibility to reflect changing site conditions

*Site surveys across the UK show that over 90% of sites would save more with iVolt® technology compared to fixed reduction solutions

iVolt® Technical Overview

Voltage Stabilisation: At the heart of the iVolt® are independently controlled auto-transformers. There are 9 tap-settings for maximum accuracy, with thyristor-based switching between each tap. The iVolt® uses the latest in thyristor switching technology to ensure stability and reliability.

A programmable micro-controller system controls the tap switching. Measuring the incoming voltage over 3,000 times per second, it selects the appropriate tap by activating the thyristor switch. The micro-controller also measures relevant frequency of the mains supply and compensates accordingly. This means that the iVolt® will work automatically over a frequency range of 45 - 75Hz and down to as low as 30Hz for short periods to help cope with diesel generator loading problems.

This combination of controllable auto-transformers and a micro-controller system results

in a voltage stabiliser which has no moving parts and responds quickly to voltage variations, providing a stable output voltage at 220V.

Spike Protection as standard: The iVolt® helps protect electrical equipment from damaging voltage spikes and surges, achieving this in two ways. Firstly, it is fitted with class II heavy duty surge arrestors at the input. In addition, the unit is fitted with Sollatek 3Ph DSP units, which incorporate Metal Oxide Varistors (MOV) at both input and output. These two design features have the joint function of protecting both the iVolt® and also all site equipment. Secondly, further MOVs are fitted on each power input to the circuit board, to protect the iVolt®'s low-voltage circuitry. The combined effect is a significant reduction in the risk of damage to site equipment, a highly reliable unit and a further improvement in power quality.

How is iVolt® different?

Real Time Energy Measurement: Integrated into every iVolt® is the unique **IRT Energy Monitor®** technology (patent pending), that enables accurate tracking of energy saving. This is the only voltage optimisation device on the market that can accurately show in real time what savings are being achieved at any given time.

Other voltage optimisers have to rely on theoretical 'modelling' assumptions, that look at production output, weather and other factors to verify savings, with data collected over several months to create a representative sample. iVolt® has an internal monitoring system, which effectively replaces the need for an Automated Targeting & Metering System (AT&Mr) system. It records energy consumption in kWh, energy saved in kWh and £, carbon and CO_2 , input and output voltage, current and power factor.

It records data to its internal microprocessor in 15 minute intervals which are then uploaded to a cloud based client portal every day. As the data is collected twice as frequently as Half Hour Metered Data (HHD) and is recorded to three decimal places, it is far more accurate than the HHD. Clients can access the information through a USB port on the front of the unit or through our secure cloud based portal which receives the data from the units GPRS modem. Multiple sites/units can be monitored and energy consumption and savings can be measured on a daily/weekly/monthly or yearly basis without the need to revert to external resources. iVolt provides power factor improvements. It sets the voltage supplied to the load at the ideal level and automatically regulates the system which gives optimum performance on all three phases regardless of input voltage fluctuations.

IRT Energy Monitor® Technology

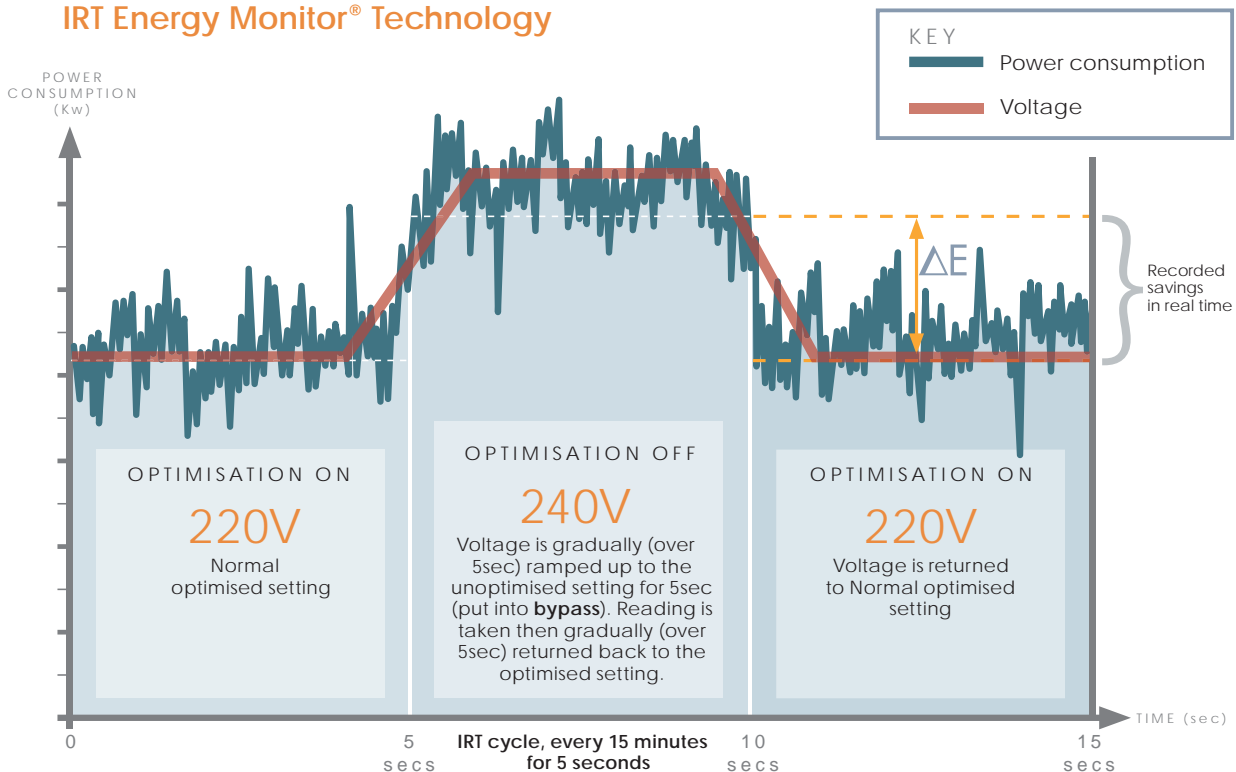

Using sophisticated software algorithms and the iVolt® variable voltage technology, the IRT Energy Monitor® measures the voltage output in

an optimised and non-optimised state every 15 minutes to compare energy consumption, with and without optimisation over a defined period.

iVolt® Specifications

Specification	
Technology	Microprocessor controlled transformer tap selection using thyristors
Capacity	32A to >3000A
Efficiency	99.4% at full load
Response time	15ms
Input voltage range	253/438 volts down to 220/380 volts
Output voltage range	220/380 volts, adjustable
Output accuracy	± 1.5%
Phase control	Three phases balanced independently
Frequency	47Hz to 75Hz
Waveform distortion	<0.25%
Transformer materials	Low loss electrical steel core with high purity copper conductors
Conductor Insulation class	Class H
Temperature class	Class B
Operating temperature	0 - 55°C
Operating humidity	95% non-condensing
Ingress protection	IP21
Overload capacity	150% for 4 minutes
Standards	BS EN 61558-1 2005, EN61000-6-4, IEC 61000-4-3, IEC 61000-4-2, IEC 61000-4-4, IEC 61000-4-5, IEC 61000-4-6, IEC 61000-4-11
Expected Service life	>25 years
Warranty	15 years (parts and labour) on all transformer windings and electronic control boards
Options	
Circuit breaker(s)	Input and/or output circuit breakers
Manual bypass	External manual bypass including isolation
Auto bypass	External auto bypass including circuit breaker for isolation
High level surge protection	Class 1 and 2 spike and surge protection Protection L - N: 25kA @ 10/350µs Protection N - PE: 100kA @ 10/350µs Voltage protection level: 1.5kV
Remote monitoring system	Connection to energy management or building management systems
Harmonic reduction transformer	Reduced power harmonics from supply and load

iVolt® Dimensions - single and three phase modular systems

iVolt Model	Amps	kVA	Width (mm)	Depth (mm)	Height (mm)	Weight (kg)
IVO63-12-2	63	14	430	370	490	65
IVO3x63-12-2	63	42	3 x 430	3 x 370	3 x 490	3 x 65
IVO100-12-2	100	22	430	370	490	80
IVO3x100-12-2	100	66	3 x 430	3 x 370	3 x 490	3 x 80

All weights and sizes are approximate. Specifications are subject to change without prior notice.

CENTRAL GOVERNMENT

“iVolt’s IRT technology has significantly improved the way we manage the site.”



John Strelitz, Senior Supply Chain Manager.
COFELY GDF SUEZ



iVolt® Dimensions - three phase systems

iVolt Model	Amps/ Phase	kVA	Width (mm)	Depth (mm)	Height (mm)	Weight (kg)
IVO3x32-12-2	32	21	430	370	590	85
IVO3x100-12-2	100	66	890	555	1285	321
IVO3x150-12-2	150	99	890	555	1285	381
IVO3x200-12-2	200	132	1000	555	1565	500
IVO3x250-12-2	250	165	1000	555	1565	512
IVO3x300-12-2	300	196	1000	555	1565	574
IVO3x400-12-2	400	264	1430	735	1565	766
IVO3x500-12-2	500	330	1430	735	1565	907
IVO3x600-12-2	600	396	1430	735	1565	920
IVO3x800-12-2	800	528	1550	735	1765	1245
IVO3x1000-12-2	1000	660	1550	735	1765	1393
IVO3x1200-12-2	1200	792	1830	785	1980	1877
IVO3x1500-12-2	1500	990	1830	785	1980	2170
IVO3x1600-12-2	1600	1056	2010	785	1980	2240
IVO3x1800-12-2*	1800	1188	1110	735	1765	915
IVO3x2000-12-2*	2000	1320	1110	735	1765	1040
IVO3x2400-12-2*	2400	1584	1255	785	1980	1320
IVO3x3000-12-2*	3000	1980	1255	785	1980	1693

Different sizes available upon request. All weights and sizes are approximate. Specifications are subject to change without prior notice.

* Made up of 3 units

iVolt® Technical Schematic

The voltage level for each phase is optimised independently using a set of two transformers controlled by an intelligent board coupled with a set of thyristors. Despite the independent function of modules, three boards are constantly communicating with each other to guarantee the highest possible performance. The iVolt system has an internal bypass feature, which safely bypasses the optimising unit in case of different types of faults, without an interruption to the customer's power supply.

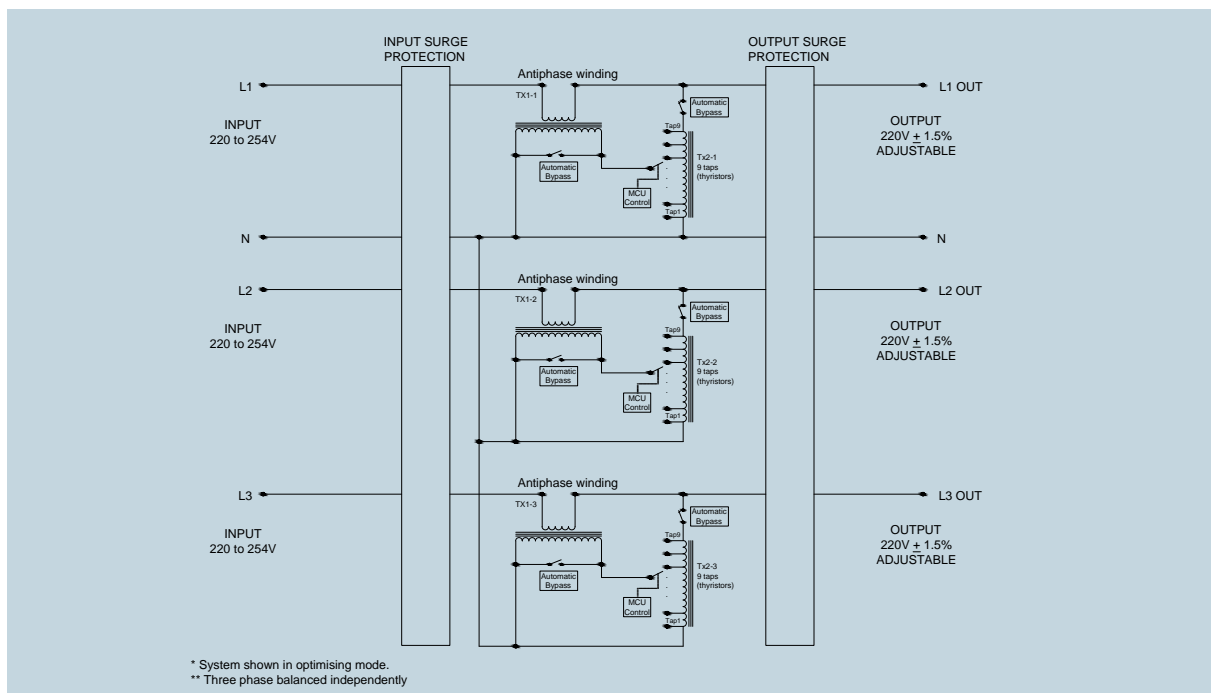

Secure cloud based portal (optional)

iVolt's own software engineers have designed and built a secure web based portal that will display vital information about actual energy performance (including savings) and power characteristics at single/multiple sites as recorded by the iVolt's IRT

monitor. This valuable software tool is beneficial to both energy managers and engineering staff. The IRT system gives instant access to the actual savings made through the implementation of the iVolt solution. This is a unique way of proving the efficacy of the savings generated solely by Voltage Optimisation and only iVolt can do this, thanks to the patented IRT technology.

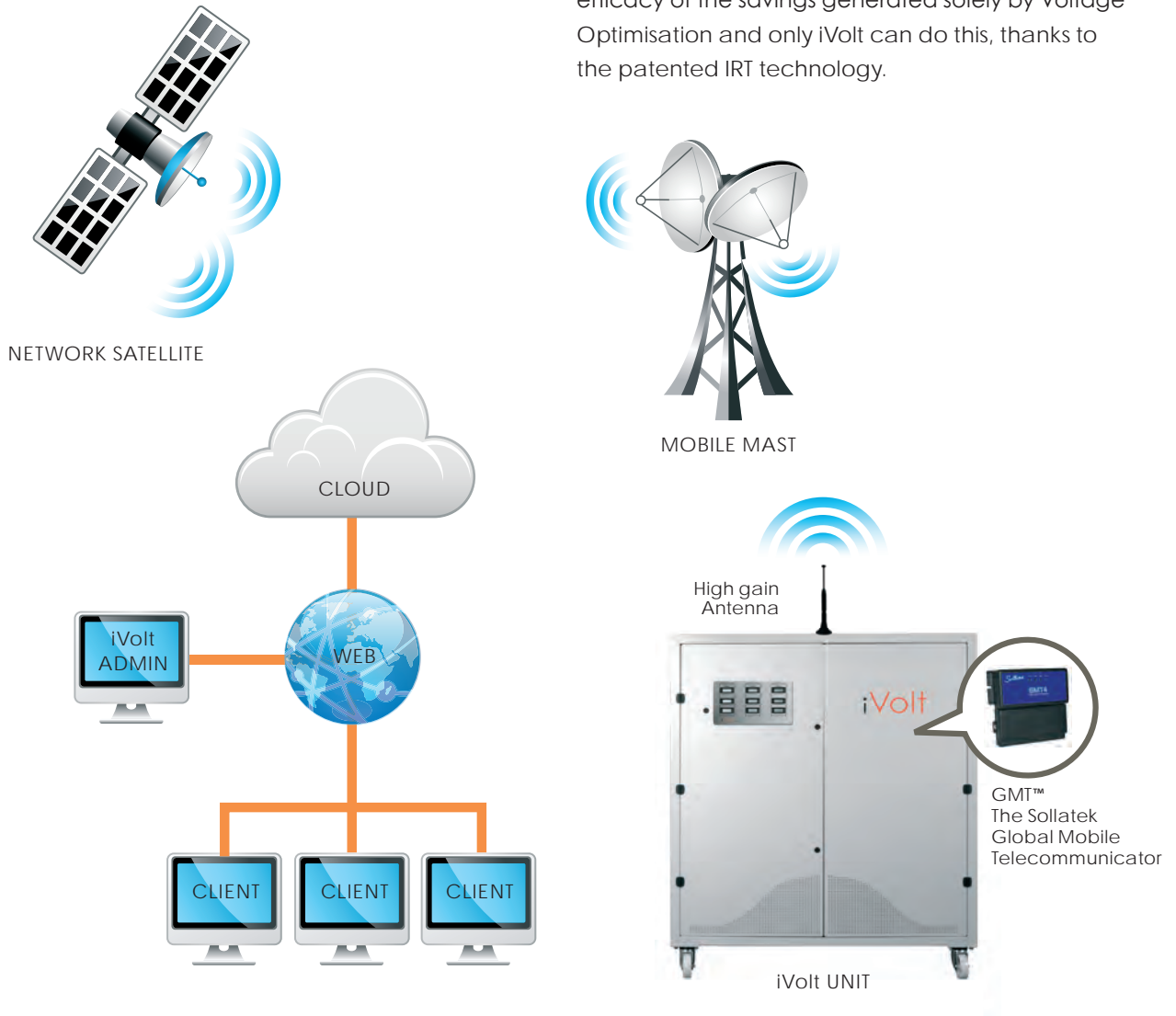

RETAIL



“ We installed iVolt units in ten stores earlier this summer and were pleased with the resulting reduction in carbon emissions. The applicable stores have seen an average reduction in energy usage of around 8% and we're hoping to see these savings replicated as we roll out across a further 40 stores in time for the Christmas trading period.”



MORRISONS Stuart Kirk, Head of Energy at Wm Morrisons Supermarkets plc. Sept 2012

Cloud based portal - user interface



Energy and financial savings data for single or multiple sites. Real time data using IRT technology. Consumption history for any given period up to 1 year.

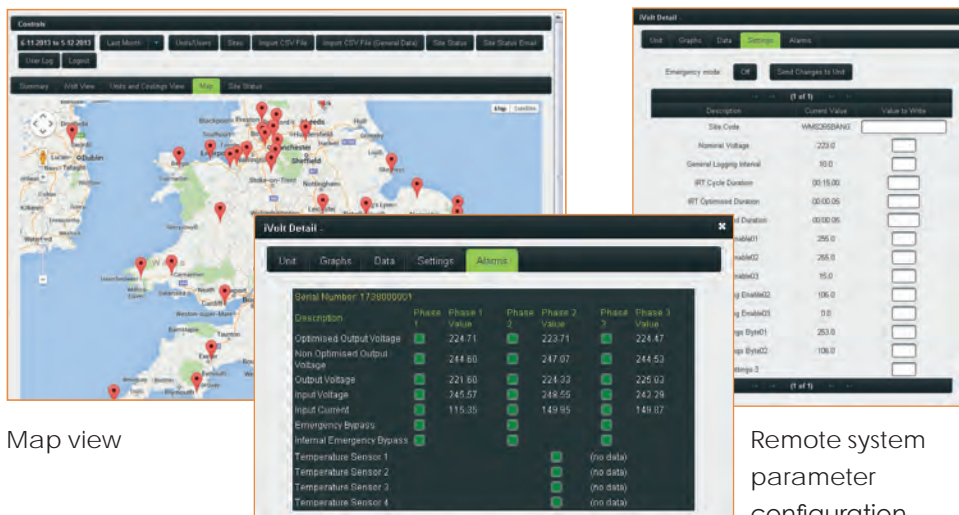

Map view

Remote system parameter configuration.

Admin view. Live alarm feature indicating change in voltage settings, IRT cycle time and temperature changes. Alarm information can be sent as SMS or email to the engineer.

Installation

All iVolt® units are installed by our technically qualified and approved installation teams. They are all NICEIC approved electrical contractors who have been trained by senior iVolt® engineers to the highest standards.

As part of the installation process, our engineers

carry out a detailed site survey.

The iVolt® survey includes a very detailed inspection of the electrical load. Based on this, we can provide you with a full cost benefit analysis of your project and also identify the savings that you will achieve.

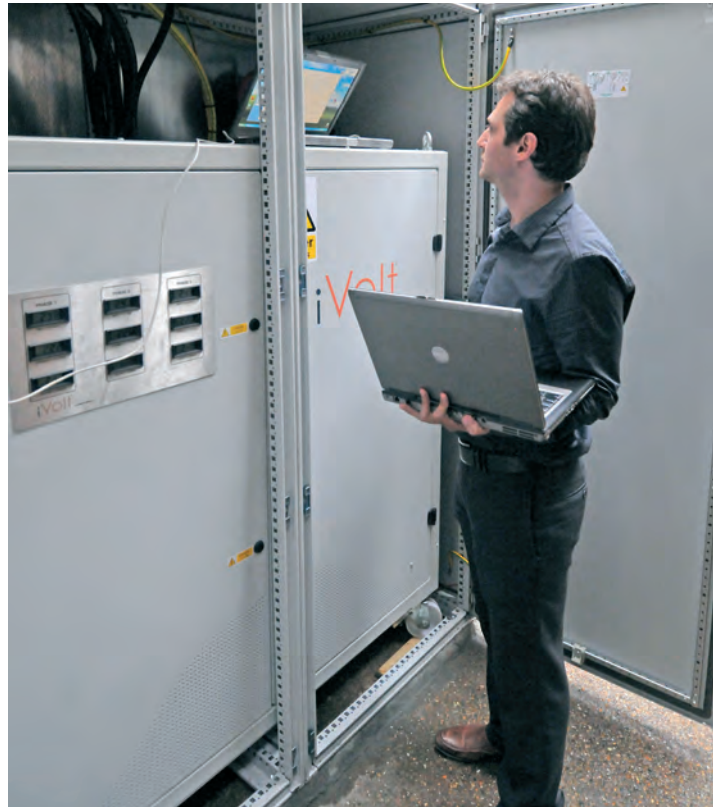
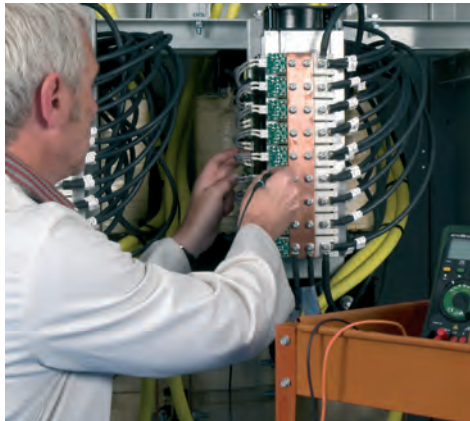

We understand that your power supply is critical to your business and a project investment needs to deliver the benefits promised.

HOTELS & LEISURE

“ iVolt were by far the most professional and knowledgeable company. We're very pleased with the savings.”



Michael Thomas
Group Financial Controller
Alexander Hotels & Utopia Spa



The Sollatek Group

iVolt is a wholly-owned division of the Sollatek Group, focusing on leveraging Sollatek's three decades of expertise in Voltage Power Stabilisation with over 440,000 units sold since 1987.

Sollatek is a world leading designer and manufacturer of voltage stabilisation systems and power solutions for a large number of industries.

Founded in the UK in 1983, Sollatek has grown

rapidly to become a truly global company with a \$30m turnover. Now with offices in 15 countries and an active distribution network in 25 more, Sollatek has an impressive list of blue chip clients in the UK and internationally.

Sollatek continues to invest heavily in R&D and manufacturing with a UK-based design and development team. The company's global manufacturing facilities are certified to the latest ISO9001 quality standards.

Sollatek has offices in 15 countries and an active distribution network in 25 more



VOLTAGE
PROTECTION



SOLAR
POWER



INTELLIGENT POWER
OPTIMISATION

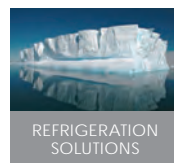

REFRIGERATION
SOLUTIONS



TELECOMS
SOLUTIONS

Sollatek manufacturing

Sollatek has successfully manufactured and installed thousands of products in major infrastructure projects, both here in the UK and globally.
As Sollatek's products have been designed

to operate in some of the most challenging industrial environments around the world, the technology has always been geared towards high reliability, with no moving parts and no maintenance required.



HEAD OFFICE: UK - SLOUGH



- Research and development
- Full prototyping facilities



- QC/QA, load and soak testing
 - 2 warehouses
- Low volume assembly

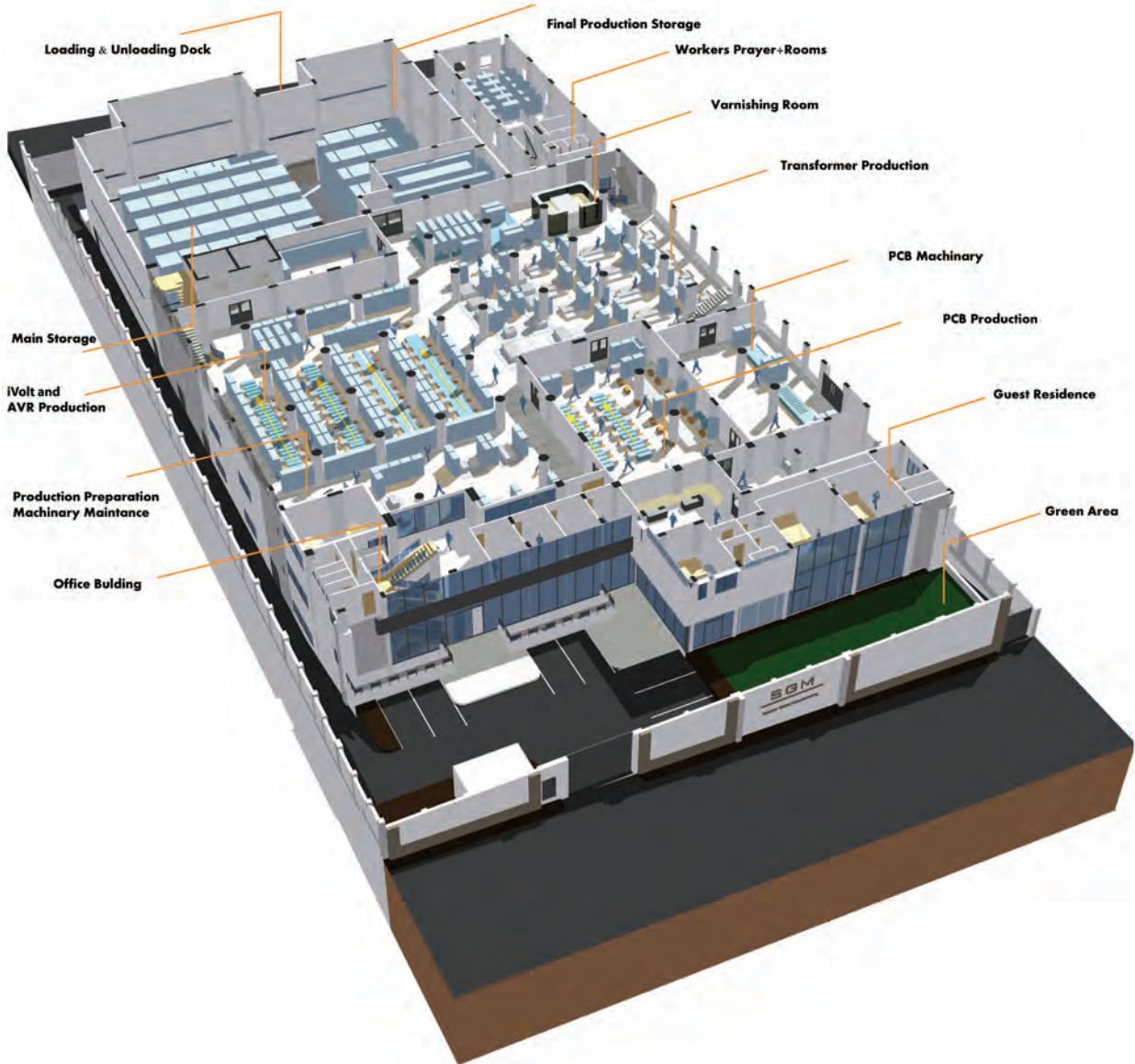

FACTORY: ALEXANDRIA



- Industrial production
- Transformer winding
- Large quality control facility
- ISO9001 certified
- Size: 1.3 acres

Our national and international clients include:



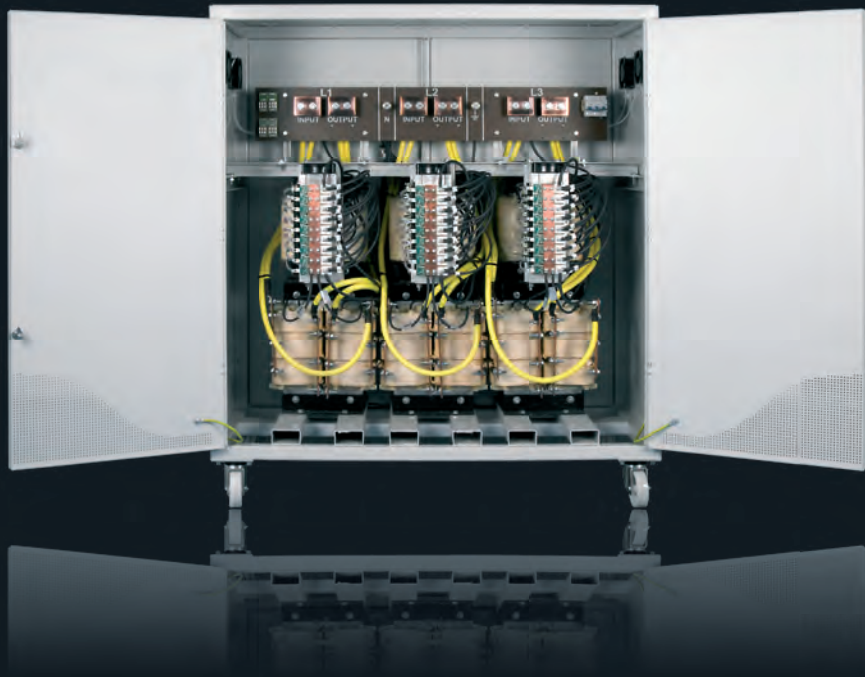

ESPO
Approved supplier

HSBC 
Global Connections - finalist

The Daily Telegraph
"One of 30 British
companies with world class potential"

**GREEN
APPLE
AWARD
WINNER
2013**

**ENDS
GREEN
ECONOMY
awards** 
**2013
FINALIST**

energy services
and technology
association

Tomorrow's FM 
Products & Services Awards
WINNER 2013

iVolt[®]
Intelligent Power Optimisation

iVolt Ltd.
Unit 9, Newlands Drive, Poyle 14 Industrial Estate, Colnbrook, Slough,
Berkshire, UK SL3 0DX
tel : 08450 75 85 80
e-mail : sales@ivoltsystems.co.uk
www.ivoltsystems.co.uk

iVolt Ltd. (a Sollatek division)



Printed on
recycled paper