



FTB42

Energy Management Temperature Controller with Display and Connectivity Options

USER MANUAL

Important: This manual contains important safety instructions. Before using this product please read all instructions carefully. Keep this manual handy for reference.

Please read the following warnings to maintain the safe function and continued performance of your Sollatek device. Failure to comply with the warnings may result in the device becoming damaged leading to premature failure or unsafe operation. In extreme cases failure to comply may cause a risk of electrocution or fire.



INSTALLATION

The mounting of the unit must be in accordance with orientation as specified in this manual. The device must only be installed and configured by trained and authorized staff.

TEMPERATURE

The Sollatek device must only be subjected to temperatures as specified in this manual.

VIBRATION AND IMPACT

The device MUST be installed in such a way as to be protected from impact in operation. Do not hit or drop the device.

NO SERVICEABLE PARTS

There are no serviceable parts inside the device. Do NOT open the housing.

VOLTAGES

The Sollatek device must only be connected to power supplies that comply with the acceptable voltage ranges as specified in this manual.

VOLTAGE FLUCTUATIONS AND SURGES

The Sollatek device has surge protection as specified in this manual. Exposure to surge voltages outside these limits, or excessively repeated surges within the limits may cause damage to the electrical circuits.

CURRENTS

Outputs should not be connected to short circuits or to loads that exceed the currents as specified in this manual. Care must be taken to ensure that cables and terminations are safely terminated.

SEGREGATION OF POWER AND SIGNAL CABLING

Correct segregation of power and signal cabling must be followed. Do not run power and signal cables together in the same conduit. Induction from power cables may corrupt data signals, leading to incorrect operation.

CONSEQUENTIAL FAILURES

The Sollatek device includes features to protect both itself and connected components. However, failure of connected components may cause damage to the controller and/or connected components. Critical or vulnerable components should be protected independently against failure.

FIT FOR PURPOSE

The Sollatek device must only be used for the purpose and functions described in this manual. As each application requires a different configuration and setup, no liability is accepted by Sollatek UK Ltd for the correct operation of the final equipment.

SAFETY PRECAUTIONS

Precautions should be taken when installing or disconnecting the device. Isolate the power supply before installation or servicing.

Trained and Authorised personnel only should install/service this equipment.

REDUCING THE RISK OF ELECTRIC SHOCK

To reduce the risk of electric shock:

1. Install the device in an area free of conductive contaminants. The ambient temperature must not exceed 60°C.
2. Use tools with insulated handles.

DISPOSAL



Sollatek devices are subject to the EU directive 2012/19/EU and may also be subject to other national legislation for the safe disposal of e-waste.

1. The device cannot be disposed of as municipal waste, and such waste should be collected and disposed of separately.
2. The device can be disposed of through an approved WEEE collection point, or alternatively can be returned to Sollatek UK Ltd at the end of its working life.
3. The device may contain hazardous substances, which if disposed of incorrectly may cause harm to the environment and/or human health.
4. Penalties may be applicable for incorrect disposal, as specified by local legislation.

Sollatek devices comply with EU directive 2011/65/EU (RoHS).

CONTENTS

1. INTRODUCTION	4	10. PARAMETERS	24
1.1 DESCRIPTION	4	10.1 HARDWARE CONFIGURATION	24
1.2 LED INDICATORS	4	10.2 RELAY CONFIGURATION (RELAY #2/#3/#4)	24
2. FUNCTION	5	10.3 TEMPERATURE CONTROL	27
2.1 TEMPERATURE CONTROL	5	10.4 ENERGY SAVING	27
2.2 ENERGY SAVING	5	10.5 DELAYS AND TIMERS	28
2.3 DEFROST CONTROL	5	10.6 DEFROST FUNCTION	29
2.4 VOLTAGE AND COMPRESSOR PROTECTION	5	10.7 VOLTAGE PROTECTION	32
3. OPERATION	6	10.8 DOOR SWITCH OPERATION	32
3.1 REGULATION OPERATION OVERVIEW	6	10.9 HEATER FUNCTION	33
3.2 DEFROST MODE	8	10.10 PROBE FAULT DETECTION (PROBE #1/#2)	33
3.3 ENERGY SAVING MODE	9	11. SPECIFICATION	34
4. FEATURES	10	12. ACCESSORIES	35
4.1 TEMPERATURE BLIND TIME	10	13. VERSION HISTORY	35
4.2 BAD VOLTAGE BLIND TIME	10		
4.3 TIMESAVE™ FUNCTION	11		
4.4 INTELLIGENT TIME DELAY	11		
4.5 TEST PINS	12		
4.6 EXTERNAL MODULES	12		
5. INSTALLATION	13		
5.1 FTB DIMENSIONS	13		
5.2 MOUNTING INSTRUCTIONS	13		
5.3 WIRING CONNECTIONS	13		
6. TEST PROCEDURE	15		
6.1 THERMOSTATIC FUNCTION	15		
6.2 DEFROST FUNCTION	15		
6.3 VOLTAGE PROTECTION FUNCTION	16		
7. ALARMS & ERRORS	17		
7.1 FREQUENCY MONITORING & ERROR DETECTION	17		
7.2 REGULATION PROBE ERROR DETECTION	17		
7.3 DEFROST PROBE ERROR DETECTION	18		
7.4 INTERNAL FAULT DETECTION	18		
8. CONFIGURATION	19		
8.1 DESKTOP CONFIGURATION	19		
8.2 REMOTE CONFIGURATION	21		
9. PROGRAMMING	22		



1. INTRODUCTION

1.1 DESCRIPTION

The FTB42 (known as FTB) is an advanced energy management temperature controller providing efficiency, optimal system performance, display and connectivity options that are suitable for all commercial fridges, coolers, and freezers.

The FTB controls up to 4 outputs including a compressor, fan, lights, and heater and has three sensor inputs for two temperature probes and one door switch. The FTB is HC compatible with Hydro-Carbon-rated relays.

The FTB provides protection to connected equipment to maximise cooler efficiency and reduce equipment damage and downtime. The FTB has zero voltage crossing for long relay life and offers complete voltage protection ensuring the controller and equipment only operate when the voltage is within set good working limits.

The FTB can be connected to a Sollatek digital display for live temperature, controller status and parameter configuration or can be connected to an external Bluetooth device for remote access to controller status and parameters reading.

DEVICE OVERVIEW

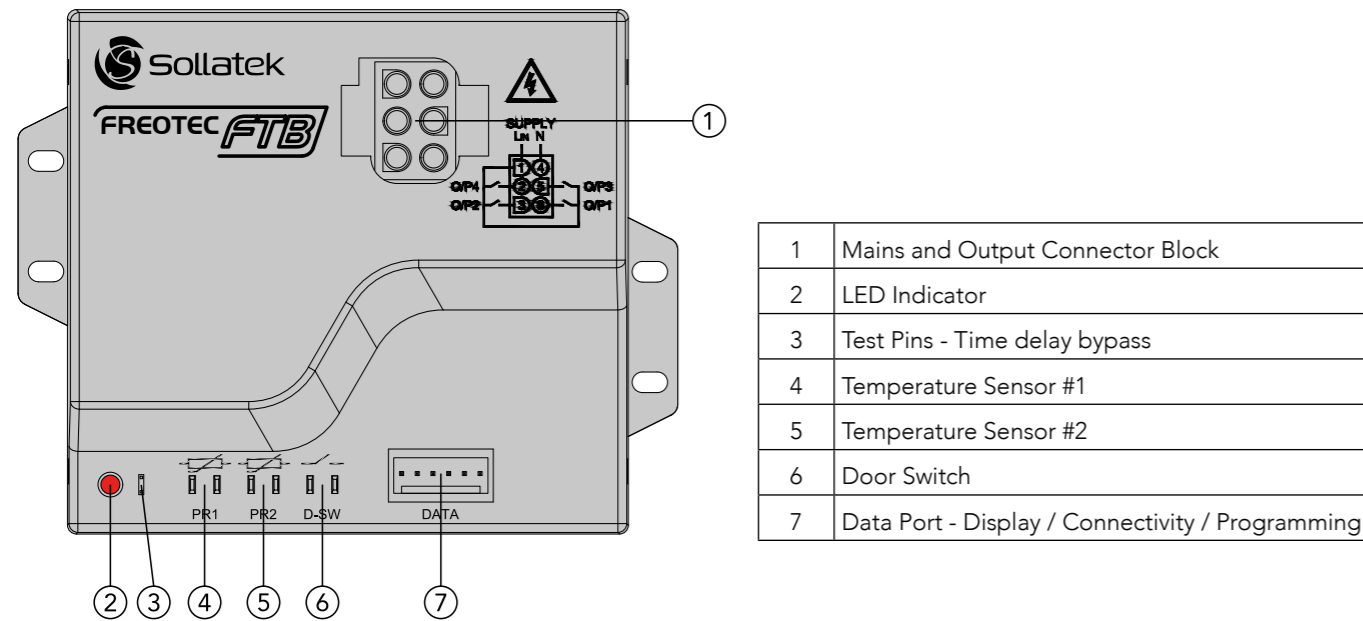

1.2 LED INDICATORS

LED Description	Mains Voltage	Compressor	Meaning
Solid ON	✓	✓	On. Voltage Good. Cooling Demand.
Flashing 0.5 sec ON / 0.5 sec OFF	✗	✗	Off. Voltage Bad. Cooling Demand.
Flashing 1 sec ON / 1 sec OFF	✓	✗	Wait Period. Cooling Demand.
Flashing 2 secs ON / 2 secs OFF	✓	✗	Wait Period. No Cooling Demand.
Flashing 4 secs ON / 4 secs OFF	✓	✗	Defrost Mode.
Flashing 0.1 sec ON / 0.1 sec OFF	✓	✗	Pre/Post Defrost Mode.
Flash fast every 2 secs	✓	△	Probe #1 Fault. Compressor Configurable.
Flash fast twice every 2 secs	✓	△	Probe #2 Fault. Compressor Configurable.
Momentarily OFF	✗	✓	Within under/over voltage blind time.
Flashing 0.1 sec ON / 0.1 sec OFF	✗	✗	Mains frequency out of range.

KEY ✓ On/good ✗ Off/bad △ Not relevant

2. FUNCTION

2.1 TEMPERATURE CONTROL

The FTB is a microprocessor-based temperature controller utilising up to two NTC (Negative Temperature Coefficient) probes. The cooler temperature is determined by measuring the temperature of either the return airflow or evaporator temperature depending on where the customer prefers to fit the probe. This probe should be connected to the probe #1 connector.

The FTB is a closed-loop temperature controller, turning the compressor OFF once the Cut-out set point has been reached and then turning the compressor ON when the Cut-in temperature is reached. Users can set both the cut-in and cut-out values via the FTB configuration interface.

2.2 ENERGY SAVING

Commercial refrigeration is energy-hungry; With rising energy costs and growing environmental concerns, the FTB allows you to reduce energy consumption. You can:

- Cycle the Evaporator Fan: Set the fan to cycle during operation as opposed to ON all the time.
- Energy Saving Mode: Reduce the cooling demand by increasing the set temperature values when there is no store activity/ at night. This will reduce how hard the compressor must work and therefore reduce energy.
- Turn OFF cooler lights: When the FTB is in energy-saving mode, the lights can be configured to switch OFF.

Note: If Energy-saving is enabled, the timer (door close duration) to activate energy-saving will start during the initial pull-down.

2.3 DEFROST CONTROL

One of the primary functions of the FTB controller is defrost management. The defrost cycle can be initiated or terminated by either time or temperature (active).

Every system is different but usually, for the most efficient and satisfactory refrigeration operation, you would set the controller parameters to initiate the fewest amount of defrosts in a day, for the shortest amount of time needed to clear the evaporator of ice.

Usually, parameters will be set to terminate due to temperature with a fail-safe time backup to prevent prolonged defrost because of defective defrost components or failures.

The FTB supports Natural or Forced Defrost:

- Natural Defrost turns off the compressor and allows the evaporator to warm up normally.
- Forced Defrost turns the compressor and evaporator fan off and then turns a reverse fan to warm up the evaporator quicker than natural defrost.

Standard operation during Defrost:

Natural Defrost		Forced Defrost		Hot Gas Defrost	
Compressor:	OFF	Compressor:	OFF	Compressor:	ON
Evaporator Fan:	ON	Evaporator Fan:	OFF	Evaporator Fan:	OFF
		Reverse Fan or Heater*:	ON	Reverse Fan or Heater*:	ON

2.4 VOLTAGE AND COMPRESSOR PROTECTION

The FTB has built-in voltage protection including High / low voltage, spikes/surges, and frequency monitoring to protect the controller and connected outputs to reduce equipment damage and downtime. The FTB continually senses the mains supply, on sensing bad voltage (voltage is higher or lower than the present acceptable limits) the FTB will disconnect the compressor and other connected outputs. Once the voltage becomes good, the FTB will ensure the voltage remains good for a set period (TIMESAVE™) before reconnecting power to the compressor and other connected outputs.

A minimum OFF period is essential in allowing compressor gases to neutralise, ensuring that the mains have stabilised before re-connection and avoiding a locked rotor condition, however, any prolonged off time can affect cooler efficiency and or the contents of the cooler. The FTB will automatically adjust the reconnection period meaning the cooler will never be off for longer than required.



3. OPERATION

3.1 REGULATION OPERATION OVERVIEW

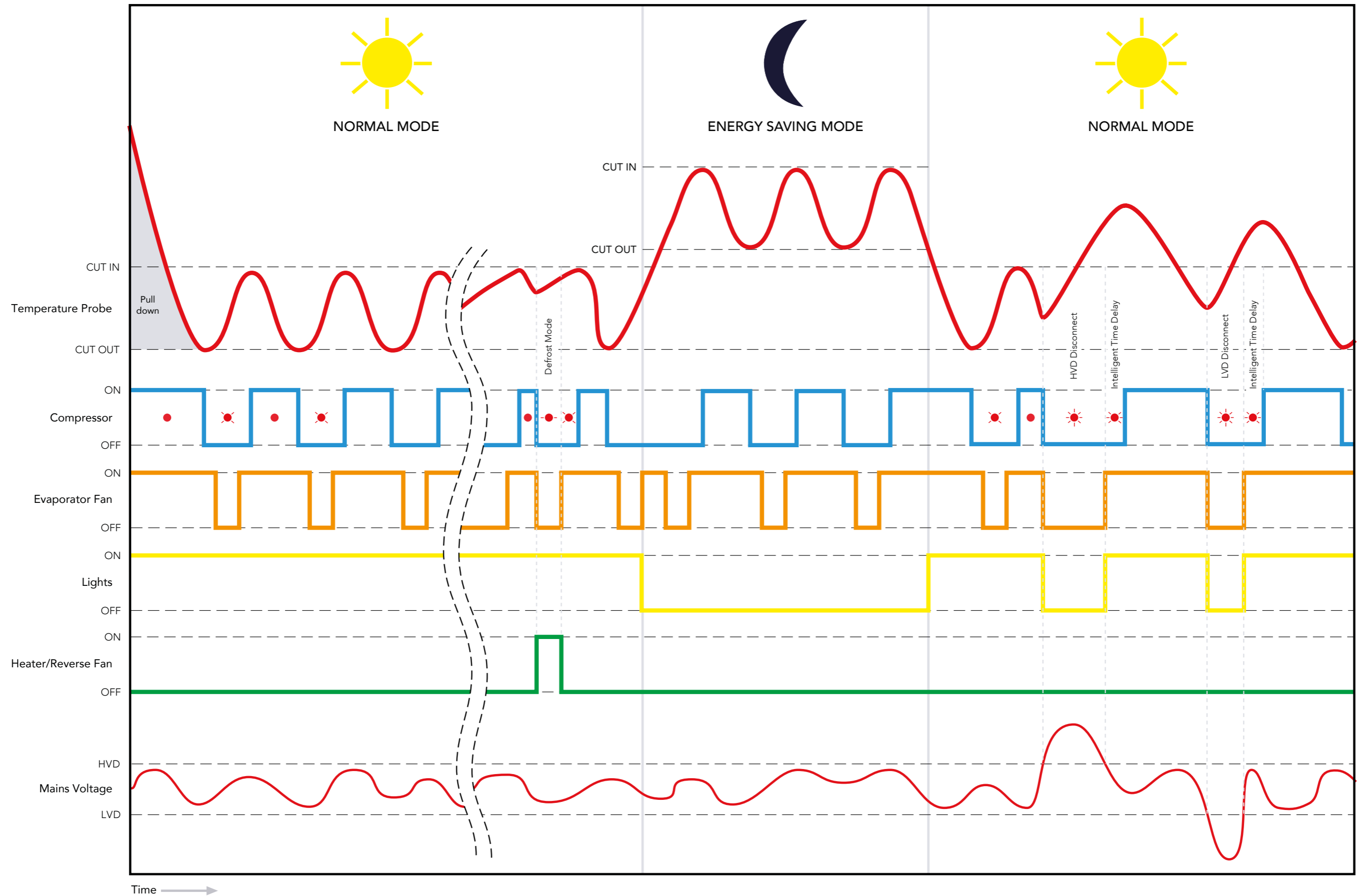

3.2 DEFROST MODE

3.2.1 STANDARD DEFROST

Depending on the requirement, defrost can be triggered by either using the temperature or/and by time, when both settings are enabled, whichever event happens first will trigger or end the defrost cycle.

The FTB has a minimum defrost duration and minimum duration between defrost cycles which must be satisfied before it will act no matter the status of the other parameters. This is to ensure the defrost cycle is not stopped too early or defrost cycles are not initiated too close together.

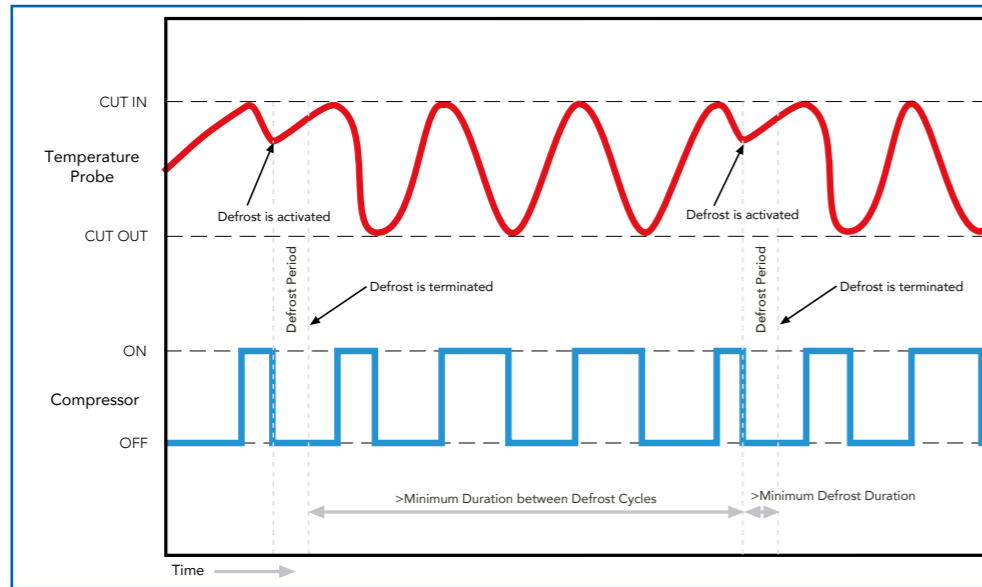

3.2.2 ADVANCED DEFROST MODES

The FTB has optional advanced pre- and post-defrost settings that provide extra protection to the controller and compressor as well as maximising defrost efficiency.

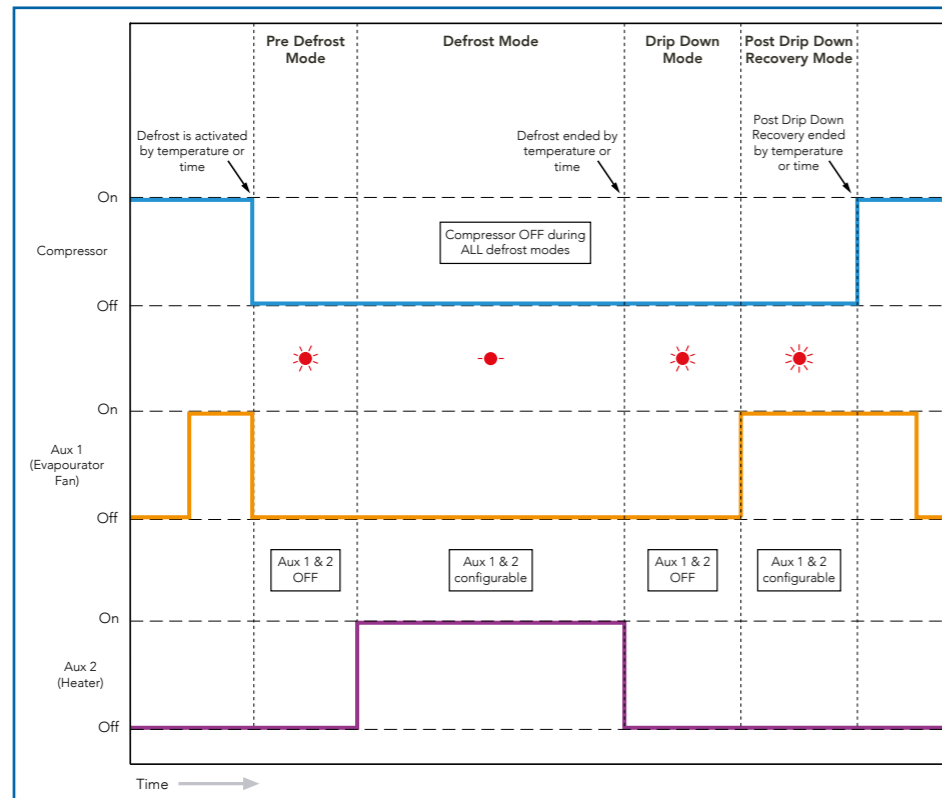

3.3 ENERGY SAVING MODE

3.3.1 STANDARD ENERGY SAVING SETTINGS

The FTB has an Energy Saving mode that provides reduced compressor operation when the outlet is closed and no customer demand by setting the cut-in and cut-out temperatures higher than in normal mode. When the FTB does not sense a door opening for the pre-set duration, then the FTB will enter Energy Saving Mode and run using the energy-saving cut-in and cut-out temperature. When the door is opened or the maximum energy-saving timer has elapsed, the FTB will resume normal operation.

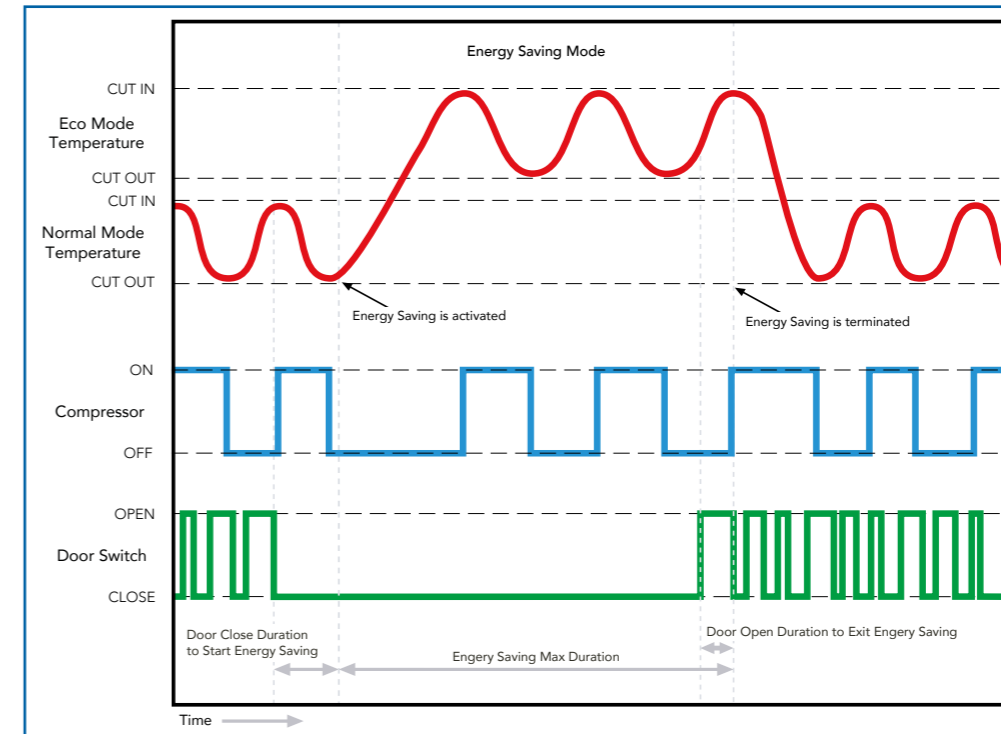

3.3.2 ADVANCED ENERGY-SAVING SETTINGS – POINT OF SALE (PoS)

If a door opening is sensed after the set Door Close Duration (PoS) has elapsed during the energy-saving mode, the FTB will record this as the start of the day. The following day the FTB will terminate energy saving 1hr before the expected start of the day, this allows the temperature of the products to reach the optimal buying temperature for the shop opening.

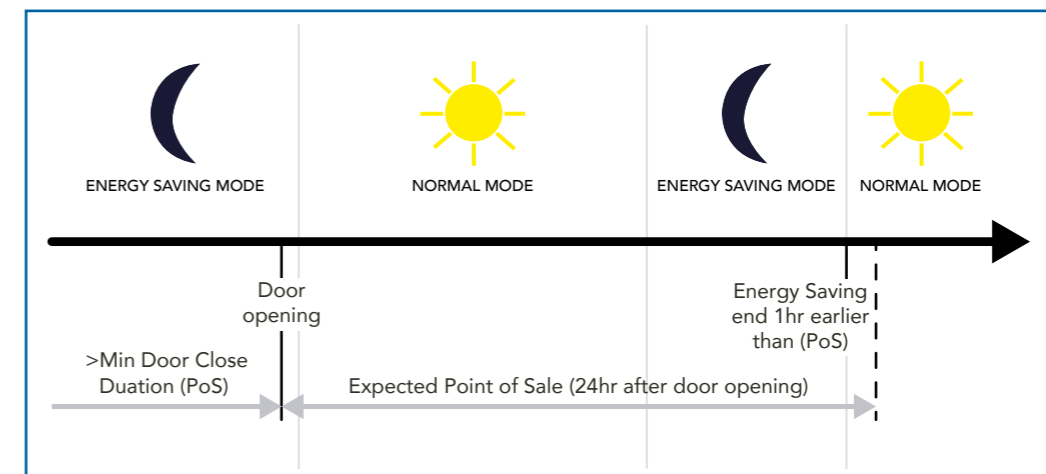

4. FEATURES

4.1 TEMPERATURE BLIND TIME

The software will ignore the sensor temperature reading for the first few seconds (a pre-set value of 10 seconds) after the compressor is switched on. This is to prevent short-term thermal effects such as those caused by the fan starting to operate causing disconnection.

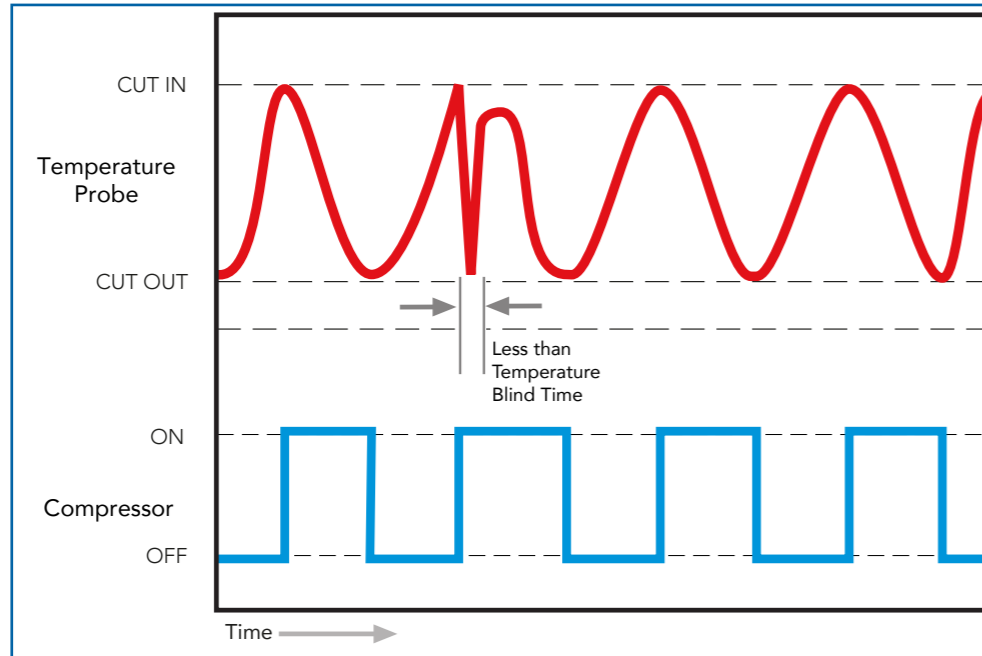

4.2 BAD VOLTAGE BLIND TIME

The software permits high and low mains voltages transitions for short periods of time preventing inadvertent compressor stop-starts. Present values of 0.5 and 2 seconds (configurable) respectively are implemented.

However, if the mains voltage becomes too extreme (HVD + 10%) and (LVD - 20%), the FTB will immediately disconnect the compressor.

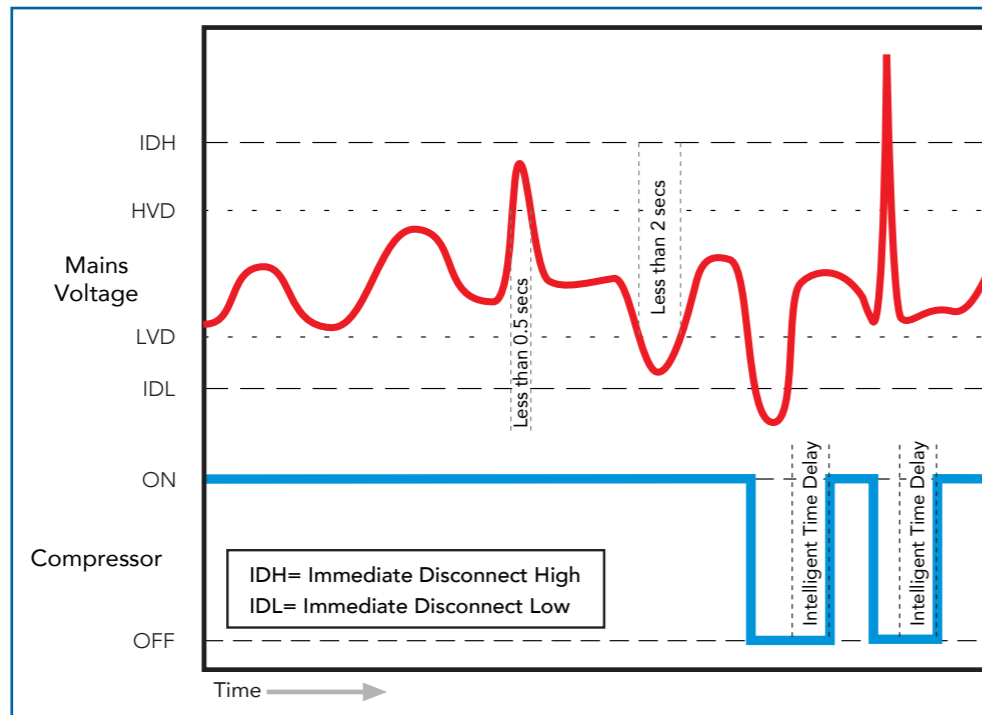

4.3 TIMESAVE™ FUNCTION

The FTB has a built-in sensing period after a bad voltage event. When the voltage returns to good after a bad voltage period the FTB will only reconnect power to the compressor and other connected outputs once it has sensed the voltage remains within set limits for at least 10 seconds.

4.4 INTELLIGENT TIME DELAY

The FTB controller has a built-in intelligent time delay of up to 5 minutes (customer configurable). After a compressor disconnection period, either from cycling OFF, defrost, or HVD/LVD the FTB will automatically adjust the time delay on the disconnection period before allowing the compressor to turn ON. For example, if the Time delay is set to 3 minutes, a 2-minute disconnection will result in only a 1-minute additional delay, making the total delay 3 minutes. Any disconnection of 3 minutes or over and the FTB will immediately turn the compressor ON.

The time delay is essential in allowing compressor gases to neutralise, ensuring that the mains have stabilised before re-connection and avoiding a locked rotor condition.

Operation of time delays during normal operation:

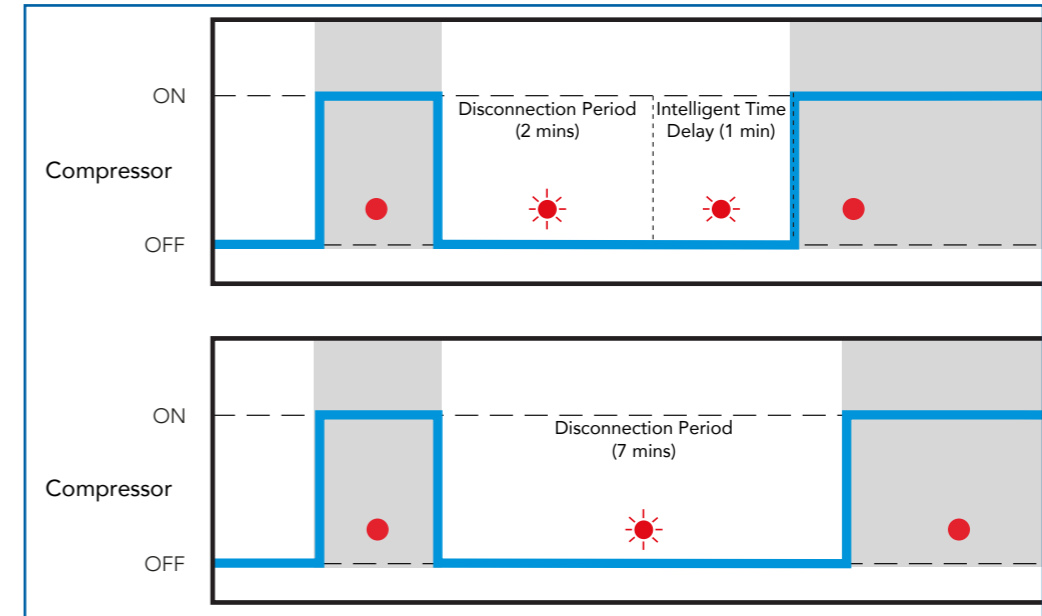

Operation of time delays during a brownout (bad voltage):

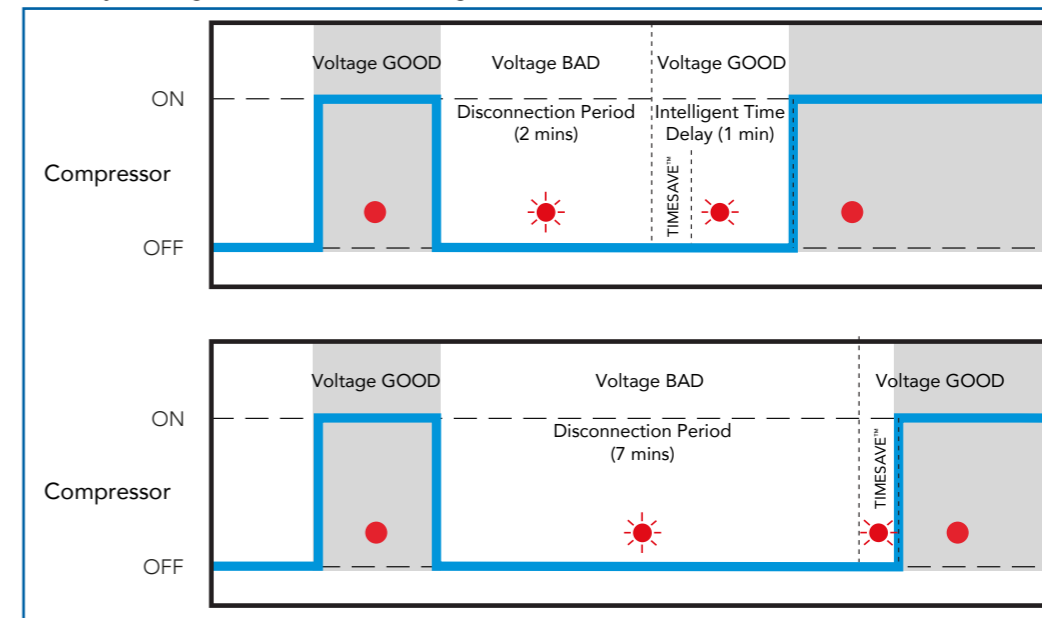

*Above illustrations use intelligent time delay set to 3 minutes

4.5 TEST PINS

Next to the LED, the FTB has two test pins. The test pins can be shorted by touching both pins with a conducting object such as a small screwdriver.

When the FTB is first turned ON and the test pins are shorted, the time delay is bypassed and will force the FTB to operate immediately according to the current temperature demand.

If the test pins are shorted during operation when there is no cooling demand, the FTB will force the compressor ON for 10 seconds to allow technicians to check the compressor operation.

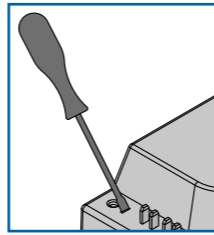

4.6 EXTERNAL MODULES

4.6.1 DIGITAL DISPLAY MODULE

The FTB can be connected to the Sollatek FDM4 and FDM5 digital displays. These allow you to:

- View and configure controller status/mode.
- Configure pre-set parameters.
- View controller alarms and faults.

4.6.2 BLUETOOTH CONNECTIVITY

FTB can be connected to the Sollatek GBR Bluetooth device, enabling the controller to connect to the Sollatek Smart Device Application. The Sollatek App has extensive cooler management capabilities providing technicians with all the tools to view and upload controller status and event data.

- Real-time Data Analysis - View real-time telemetry data, operational status, and performance data.
- Cooler Event Log - Access all historical data that has occurred between store visits to identify any issues or problems.
- Manage Settings and Parameters - View and configure predefined FTB controller parameters for cooler optimisation. Set BLE Beacons protocols and event logging.
- Connect to the Cloud - Upload data to the cloud for access on the online portal for further analysis.

The GBR also features iBeacon and Eddystone Beacon capabilities allowing proximity marketing to send engaging and interactive content to consumers' smartphones while they buy in real-time.

5. INSTALLATION

5.1 FTB DIMENSIONS

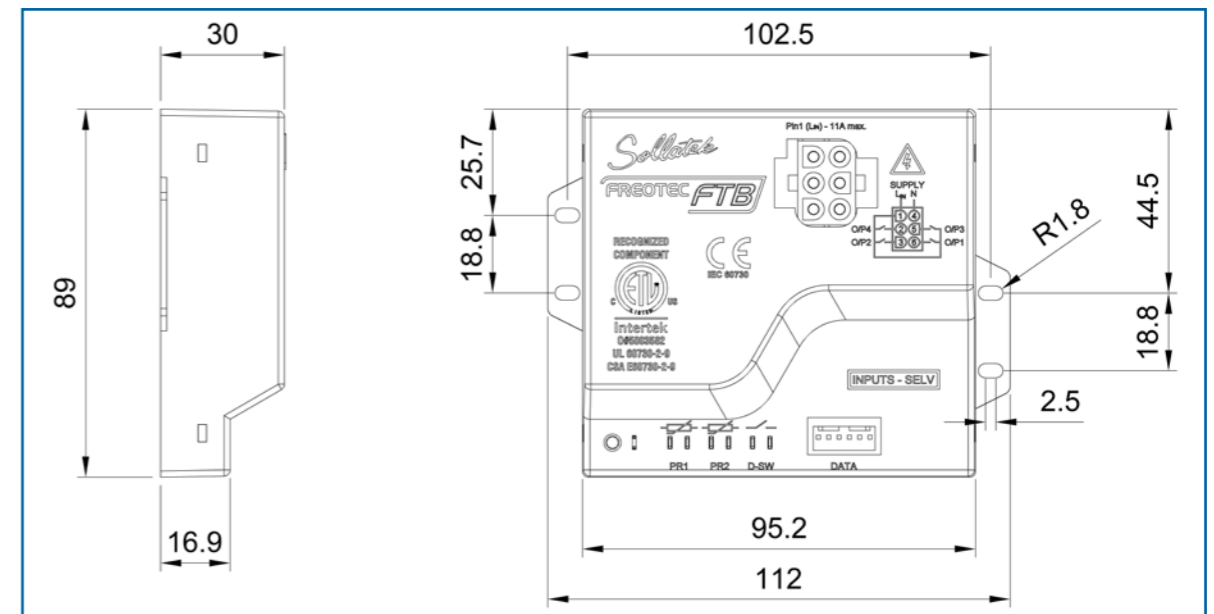

5.2 MOUNTING INSTRUCTIONS



WARNING!

FTB **MUST** be mounted with terminals in an isolated area, either in a plastic or earthed metal case.

1. Mark and drill pilot holes in the surface where the FTB is to be mounted. Ensuring the holes are free of burrs and sharp edges.
2. Place the FTB in place and insert the provided screws into the holes.
3. Tighten the screws using a screwdriver to secure the FTB into position.

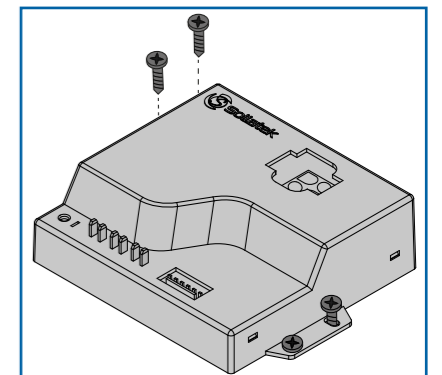

5.3 WIRING CONNECTIONS

5.3.1 MAINS AND OUTPUT WIRING



WARNING!

Isolate the supply before accessing the controller. Failure to do so can result in damage to equipment and electrical shock. This Equipment is to be installed or serviced by trained personnel only.

Ensure the connected load does not exceed the maximum relay rating it is connected to and the total current rating ON at once does not exceed 11 Amps.

Mains and output connections are made via the 6-way. Connections should be made with an equivalent 6-way male connector.

1. Connect Mains Live-In to pin 1.
2. Connect Mains Neutral to pin 4.
3. Connect the Compressor to pin 6 (Output 1).
4. Connect the Evaporator Fan to pin 5 (Output 3/relay#3) (if required).
5. Connect the Lights to pin 2 (Output 4/relay#2) (if required).
6. Connect the Heater/Reverse Fan to pin 3 (Output 2/relay#4) (if required).

Note: Output connectors are based on the default relay configuration, if the output configuration is changed via the FTB configuration interface, then the equipment should be connected accordingly.

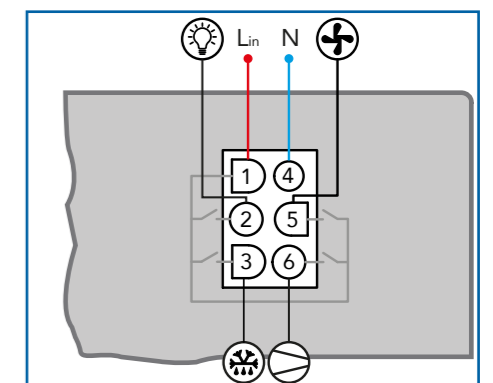

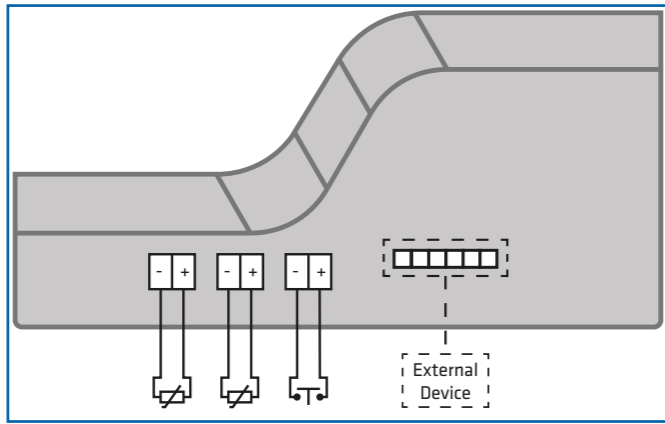

5.3.2 INPUT SENSOR WIRING



WARNING!

Isolate the supply before accessing the controller. Failure to do so can result in damage to equipment and electrical shock. This Equipment is to be installed or serviced by trained personnel only.

Separate as much as possible the input sensors and cables carrying inductive load and power. Do not run power and signal cables together in the same conduit.

0.11" vertical male spade terminals are used for the input connectors on the FTB. Temperature probes and the door switch use a 2-way female crimp terminal connector.

Note: Ensure the crimp connectors of the sensors are pushed firmly onto the terminal.

1. Connect the regulating temperature probe (typically air) to terminal PR1 on the FTB.
2. Connect the second temperature probe (typically evaporator) to terminal PR2 on the FTB (if required).
3. Connect the door switch to terminal D-SW on the FTB (if required).

5.3.3 EXTERNAL DEVICE CONNECTION



WARNING!

Isolate the supply before connecting/repairing/disconnecting external devices. Failure to do so can result in damage to equipment and electrical shock.

Do not power the controller with connecting cables unconnected to devices as if exposed connectors were to touch the frame or chassis of the cooler, damage to the controller, equipment, and the cooler will occur.

Separate as much as possible the input sensors and cables carrying inductive load and power. Do Not run power and signal cables together in the same conduit.

1. Insert the 6-way connector of the connection cable into the module port on the FTB. Ensure the connector is fully pushed down.
2. Plug the other end of the connector cable into the connector on the back of the display/top of the GBR device.

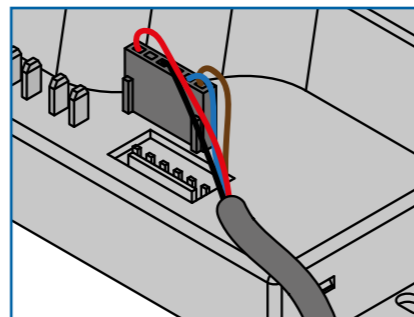

6. TEST PROCEDURE

6.1 THERMOSTATIC FUNCTION

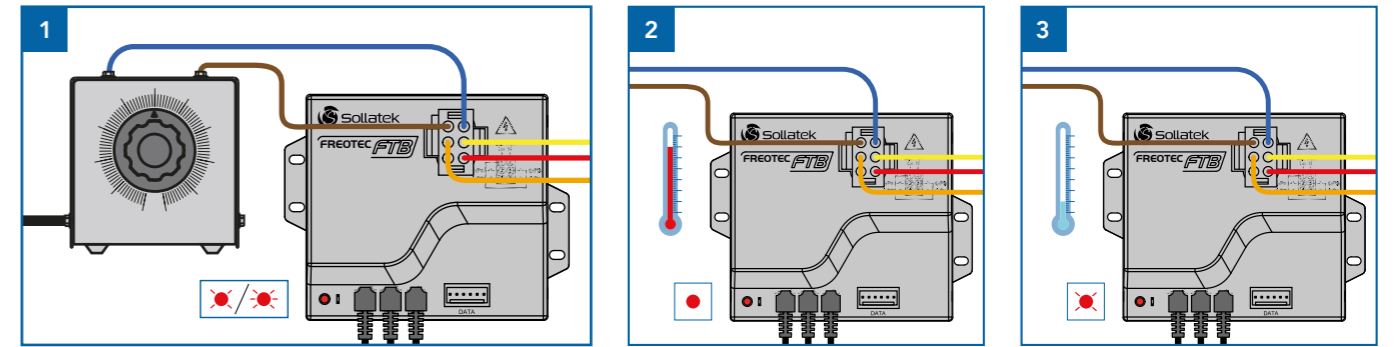

1. Connect the cooler to a source of variable AC voltage such as a Variac. Adjust the output of the Variac to a good starting voltage (within the set limits). The Red LED will flash at a rate of 2 seconds ON / 2 seconds OFF if the temperature detected by the regulation temperature probe (Probe#1) is below the cut-in temperature. If the temperature is above the cut-in value, then the LED will flash at a rate of 1 second ON / 1 second OFF.
2. When the Intelligent Time Delay is over, the FTB will connect the mains supply to the compressor (assuming the temperature sensed by Probe#1 is above the cut-in temperature). The red LED will be ON.
3. Once the cabinet has reached the desired temperature (the temperature sensed by Probe#1 drops below the cut-out temperature), the FTB will disconnect the compressor and the Red LED will flash at a rate of 2 seconds ON / 2 seconds OFF (which indicates incoming voltage is good and compressor satisfied).

6.2 DEFROST FUNCTION

Standard Defrost Operation

Note: This test may take a long time to wait for either the defrost start time to be over or for the evaporator temperature to drop below the defrost start temperature.

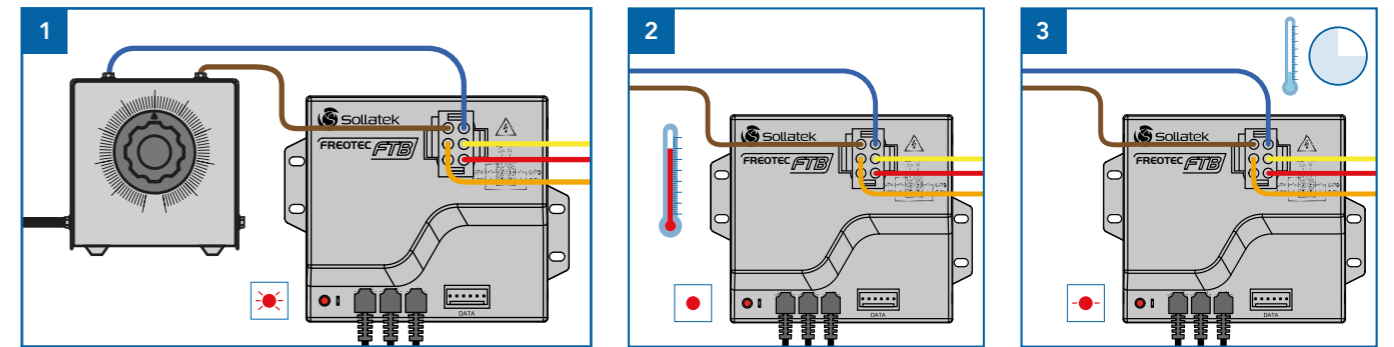

1. Connect the FTB to a variable power source such as a variac and ensure the output of the Variac is at a good starting voltage (within the set limits). The red LED will flash at a rate of 1 second ON / 1 second OFF for the duration of the protection time delay (assuming the temperature is above the cut-in value).
2. When the Intelligent Time Delay is over and assuming the measured temperature is above the cut-in value, the FTB will energize the load and the red LED is now ON.
3. The unit will go into defrost as soon as one of the defrost start criteria is met. This could be either defrost start time is over or the defrost temperature drops below defrost start temperature value, whichever happens first, or is activated. The Red LED will flash 4 seconds ON / 4 seconds OFF, and the compressor and other outputs will act according to the set operation, turning ON if set to ON.
4. The unit will stay in defrost until one of the defrost end criteria is met. This could be either defrost end duration is over or the evaporator temperature has risen above defrost end temperature value, whichever happens first, or is activated.

Test Operation - Immediate Defrost at Power UP Enabled

1. Connect the FTB to a variable power source such as a variac and ensure the output of the Variac is at a good starting voltage.
2. When powered up, if the defrost enable temperature is met, the FTB will enter defrost. The Red LED will flash 4 seconds ON / 4 seconds OFF, and the compressor and other outputs will act according to the set operation, turning ON if set to ON.
3. When the immediate defrost duration has elapsed, the FTB will resume normal operation according to the set parameters.

Note: Ensure to disable this feature and reprogram the FTB before sending the cooler/controller to market.



6.3 VOLTAGE PROTECTION FUNCTION

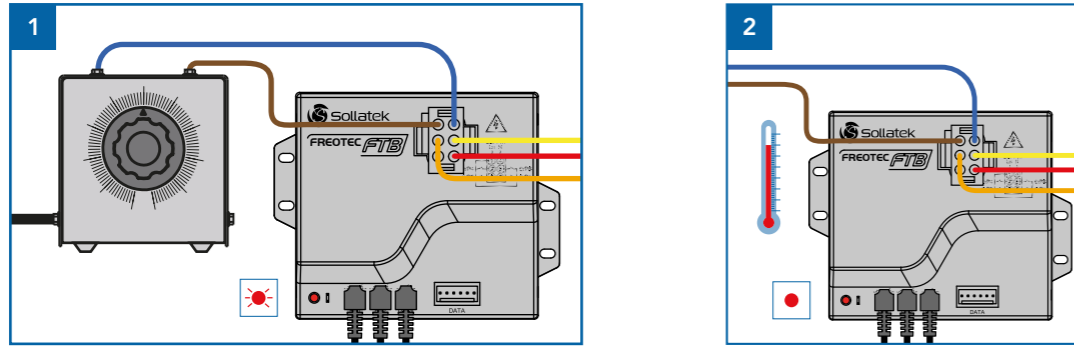

1. Connect the FTB to a variable power source such as a variac and ensure the output of the Variac is at a good starting voltage (within the set limits). The red LED will flash at a rate of 1 second ON / 1 second OFF for the duration of the protection time delay (assuming the temperature is above the cut-in value)
2. When the Intelligent Time Delay is over and assuming the measured temperature is above the cut-in value, the FTB will energize the load and the red LED is now ON.

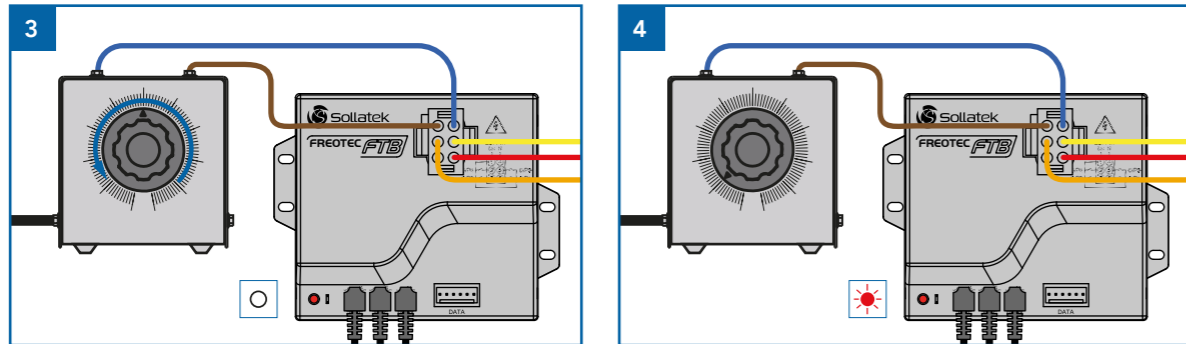

3. Slowly decrease the voltage until the Red LED momentarily switches OFF. The Red LED will stay OFF for the duration of the Under Voltage Blind Time (2 seconds).
4. Then the FTB will disconnect the outputs and the Red LED starts flashing fast at a rate of 0.5 seconds ON / 0.5 seconds OFF. This represents the Low Voltage Disconnect voltage.

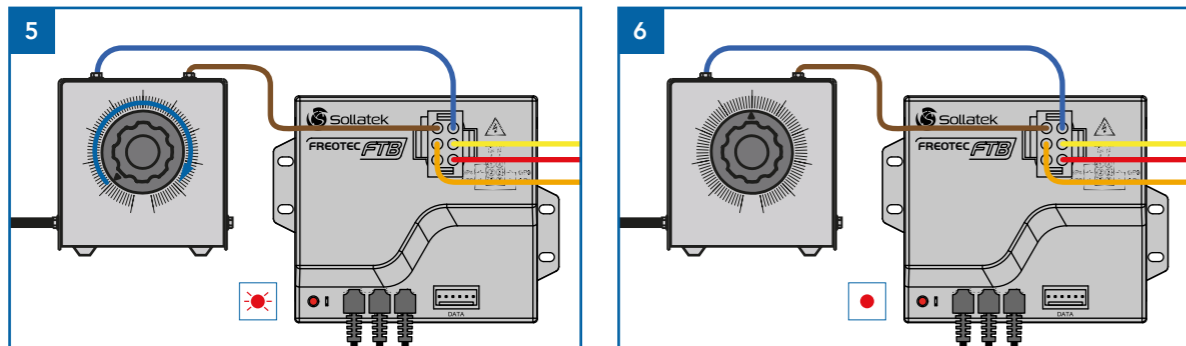

5. Increase the voltage slowly until the Red LED starts flashing at a slower rate (1 second ON/1 second OFF). This represents the Low Voltage Reconnect voltage.
6. Wait for the Protection Time Delay, then the Red LED will be ON.
7. Repeat steps 3 to 6 but increase the voltage to test the overvoltage.
 - The High Voltage Blind Time is 0.5 seconds.

Note: Low/high Blind Times are Sollatek's recommended timings. Blind times are configurable in the desktop configuration interface so actual timings may differ from the times stated depending on your settings.

Tip: During testing, short the test pins to bypass the set time delay and force the FTB to operate immediately

7. ALARMS & ERRORS

7.1 FREQUENCY MONITORING AND ERROR DETECTION

The FTB dynamically measures the frequency of the mains supply and reacts accordingly. If the mains supply frequency is too low or too high, the FTB will then disconnect the compressor and indicate an error signal through the LEDs. The FTB can auto-recover once the frequency is within acceptable limits.

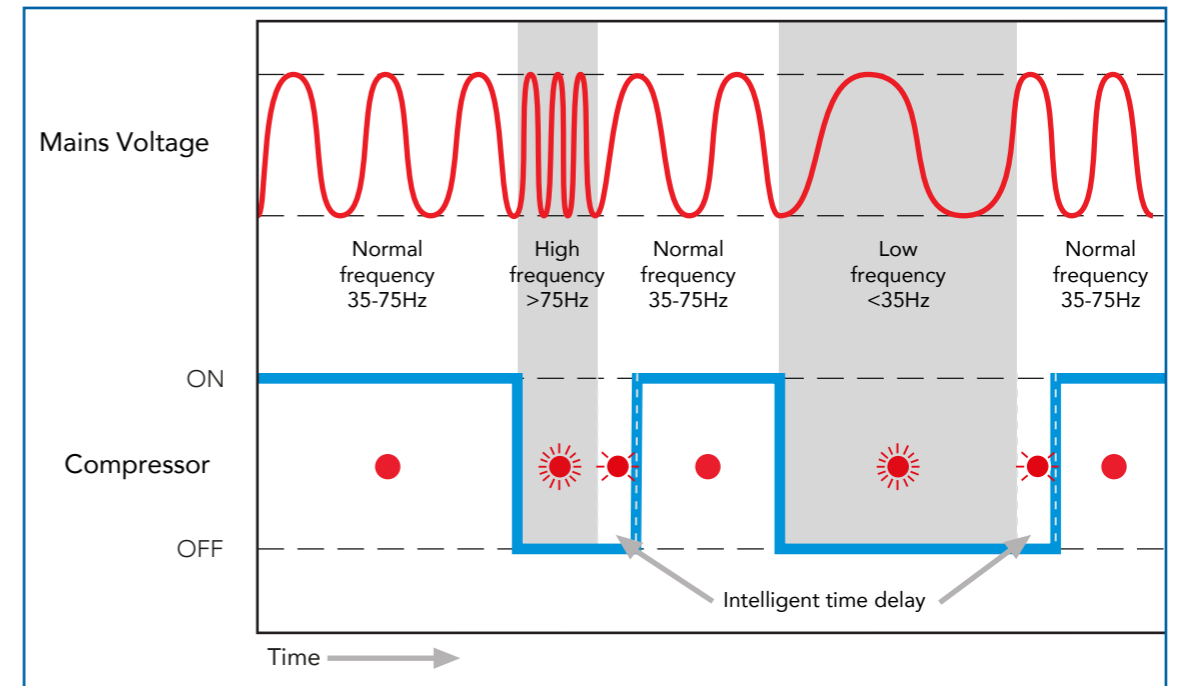

Note: The above illustration assumes that the Mains voltage RMS value is good and there is cooling demand, hence the compressor comes on after the intelligent time delay is over.

7.2 REGULATION PROBE (PROBE#1) ERROR DETECTION

The FTB will report an error code through the LEDs indicating a sensor fault if it happens. Depending on customer preferences the FTB will either:

Scenario One: Detect the fault and disconnect the compressor until the problem is resolved and then the system resumes normal operation.

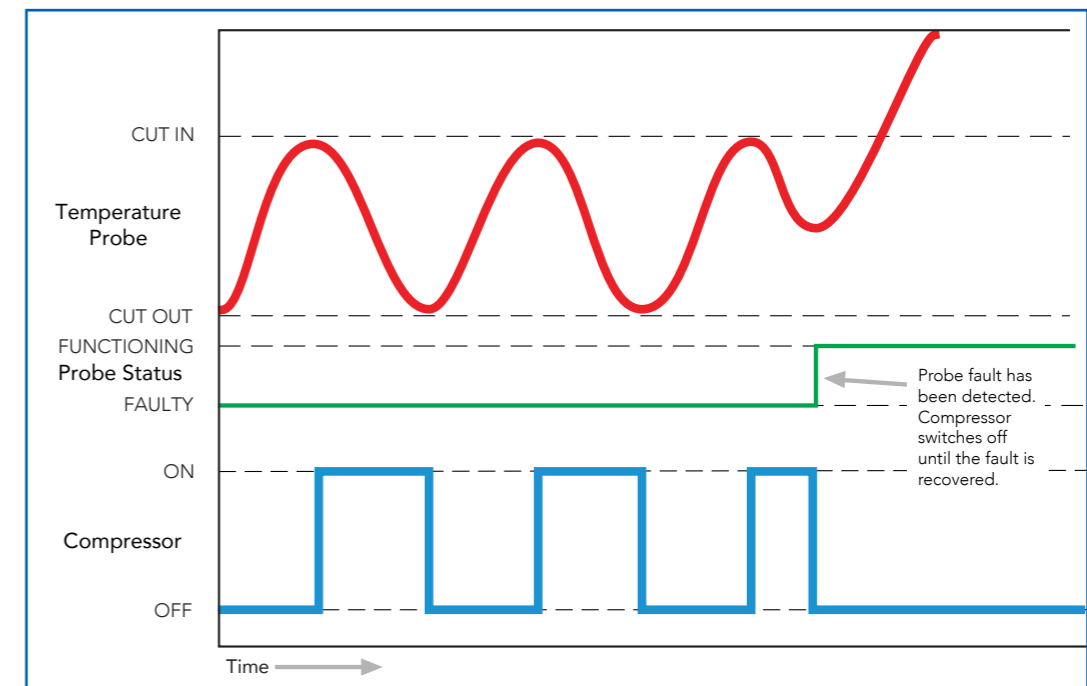

Scenario Two: Detect the fault and cycle the compressor on and off for a pre-set time regardless of the cooler temperature. Once the problem is resolved the system will resume normal operation.

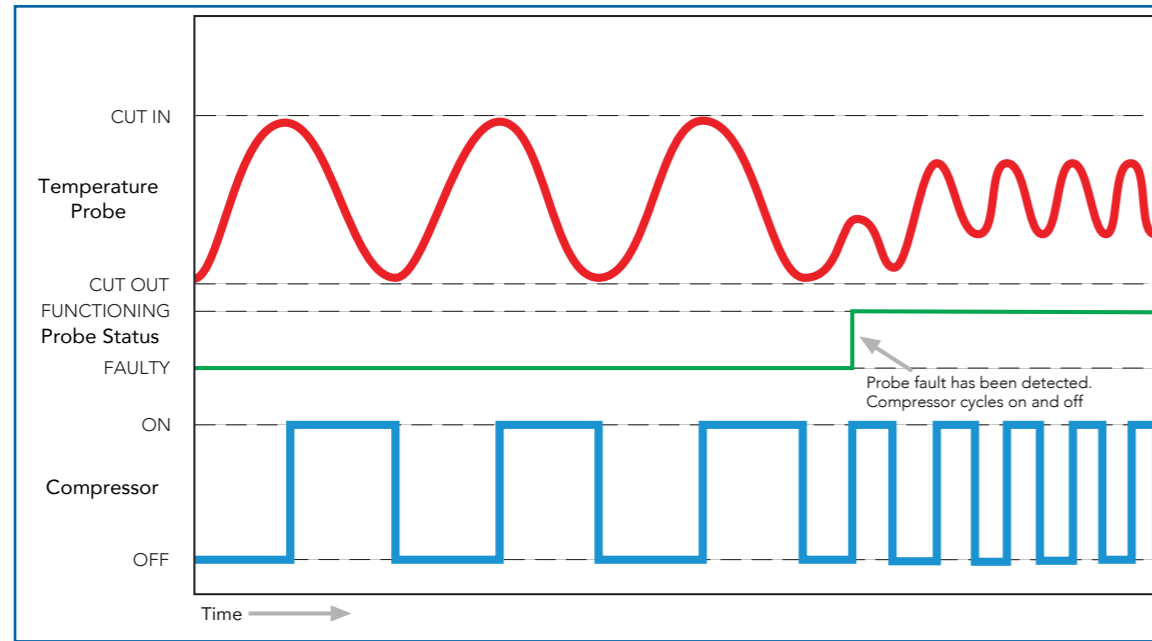

7.3 DEFROST PROBE (PROBE#2) ERROR DETECTION - EMERGENCY DEFROST MODE

If the defrost probe is faulty, the FTB will enter emergency defrost mode (if enabled). In emergency defrost mode, the FTB will ignore set defrost parameters and enter a state of continuous defrost cycling based on set parameters.

For example: The emergency defrost start time is set to 1 hour and the emergency defrost end time is set to 20 minutes. After an hour after a defrost probe fault has been detected, the FTB will enter defrost for 20 minutes before resuming normal operation for 1 hour and so on until the probe fault has been fixed.

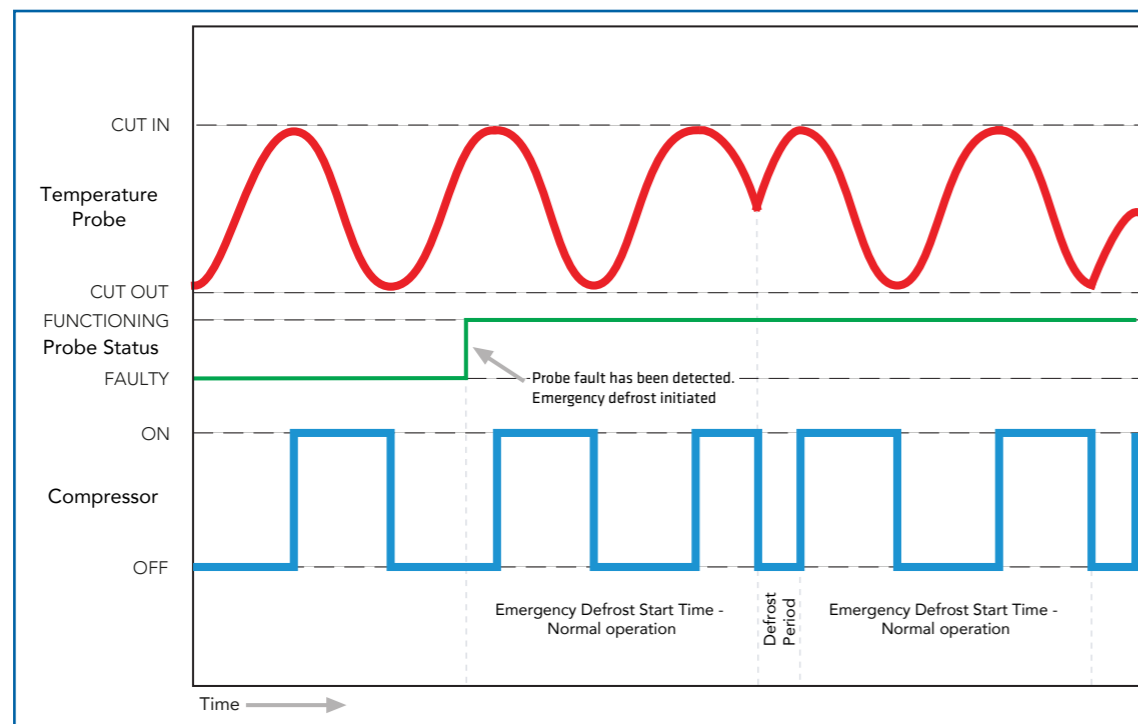

7.4 INTERNAL FAULT DETECTION

If an internal fault within the FTB is detected, it is reported through the LED indicator. If the fault does not automatically clear and resumes normal operation, then please contact Sollatek for help and advice.

8. CONFIGURATION

8.1 DESKTOP CONFIGURATION

The desktop configuration Interface is designed to set all refrigeration control parameters of the FTB, (see section 9. Parameters for a full list of parameters).

8.1.1 INSTALLATION AND LOGIN

- Run the .exe file provided by Sollatek.
- Follow any security notifications to allow your PC to install the software.
- The installer wizard window will appear on the screen. Follow the on-screen instructions in the wizard and enter the company name and password, as provided by Sollatek.
- The files and data will be automatically extracted without any user intervention. Progress will be indicated on the status bar within the wizard.
- Once the desktop configuration Interface has been installed on your computer the wizard will display a success message and the program shortcut will be saved on your desktop.
- Click Finish to close the wizard window.
- The desktop configuration Interface can be opened by searching in the start menu or clicking on the desktop shortcut.

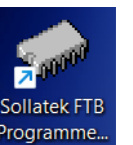

8.1.2 HOME WINDOW

When the desktop configuration interface is opened, the configuration interface window appears. The menu bar includes File, Tools, and Help which have all the options for you to be able to configure/program the FTB.

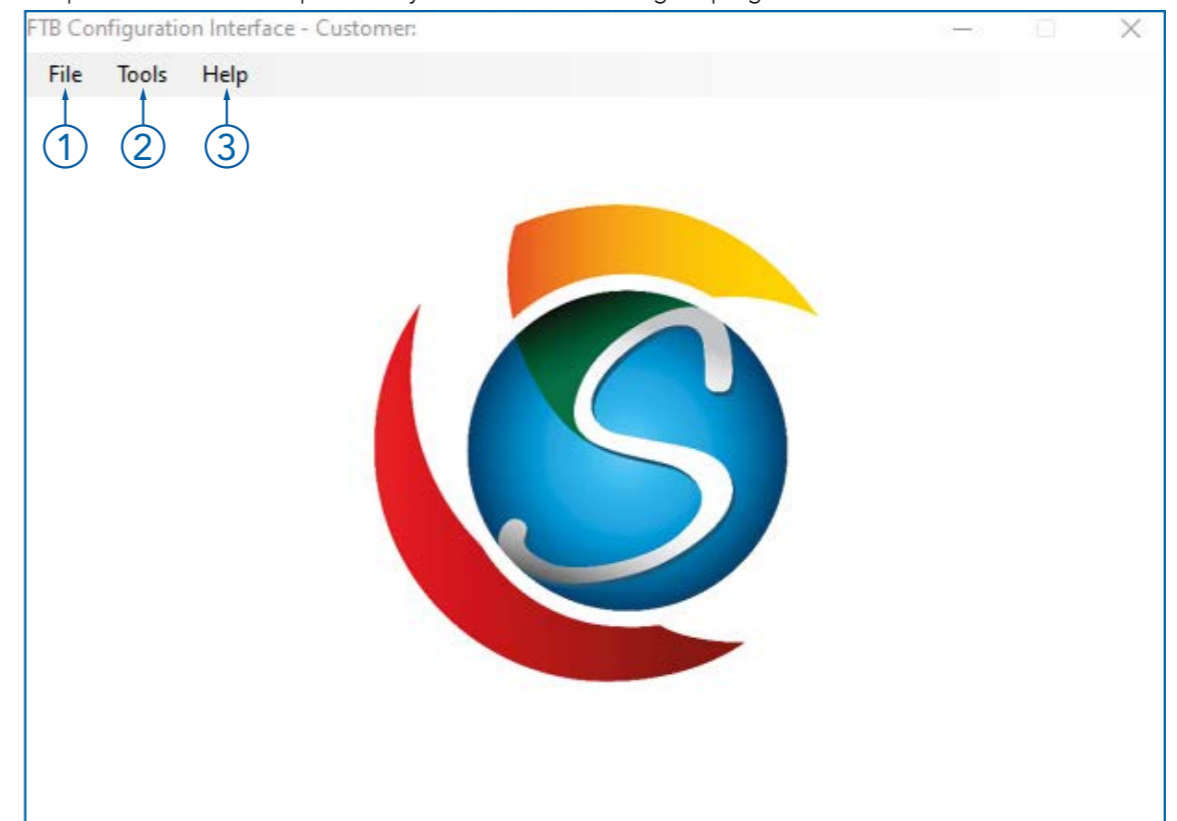

Menu Item	Description
1. File	New - open a blank configuration where values are set to default. Open - Open a configuration file saved on your PC.
2. Tools	Program - Program an SPP02 with a saved configuration file without loading it into the configuration software.
3. Help	About Programmer - Software details including software version.



8.1.3 PARAMETER CONFIGURATION WINDOW

The software is intuitive, so certain options can only be adjusted if a corresponding option is selected for example: Relay #3 configuration will only be accessible if the number of outputs in the hardware configuration is set to 3.

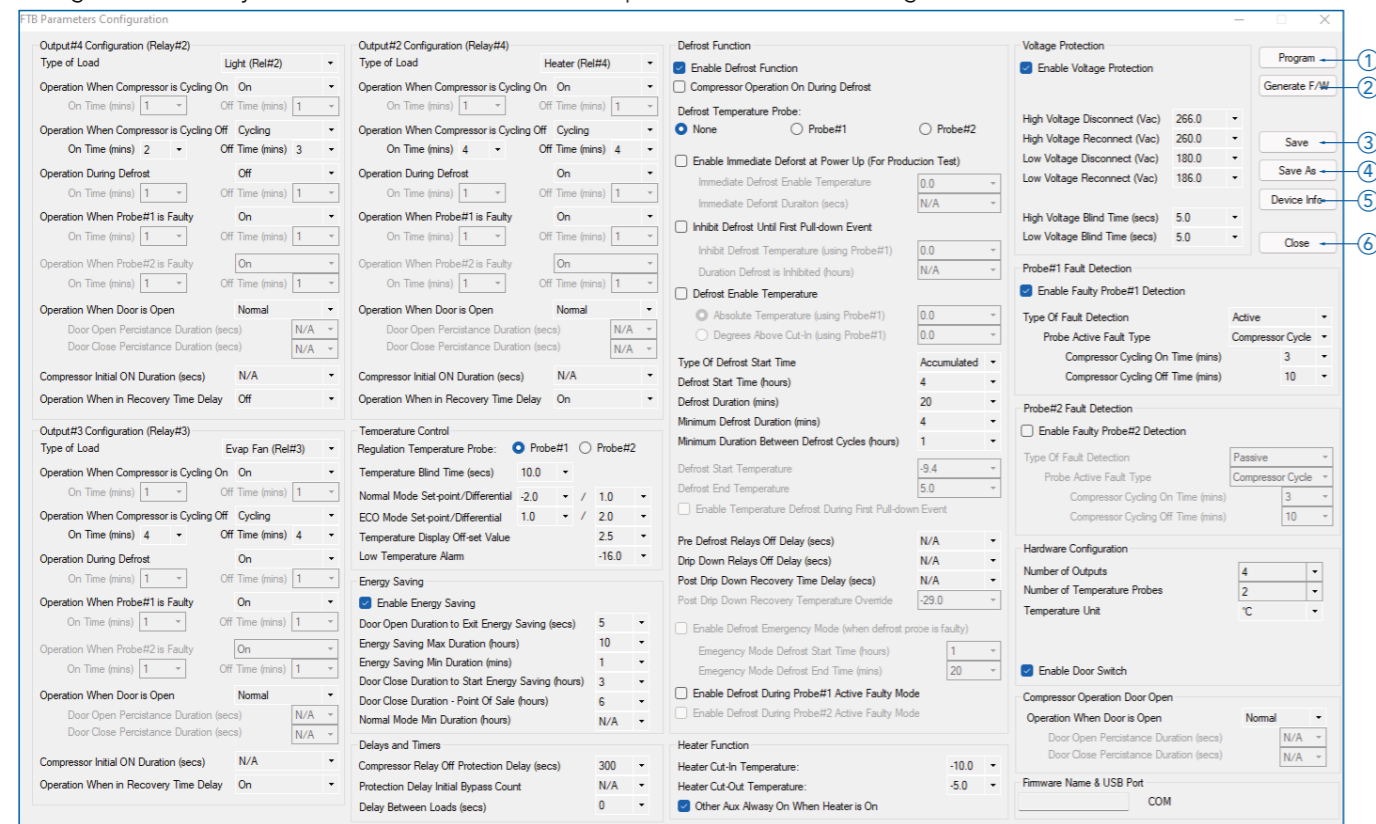

Button	Description
1. Program	Program current configuration & firmware to the SPP02.
2. Generate F/W*	Save the configuration and firmware as program files on your computer. Several files will be saved in the file location of your choice. .s19 & option.s19 files will be used to program the FTB. .cfg file is the parameters set in the desktop configuration interface. .stp file can also be used to program the FTB.
3. Save	Save the current configuration as a file on your computer. If saving for the first time you must select the file name and location. Thereafter the file will overwrite the existing file.
4. Save As	Save a copy of the current configuration with a different name or different file location on your computer.
5. Device Info	Collect and view device information from a connected controller.
6. Close	Close the parameter configuration window - if changes have been made you will be prompted if you want to save the changes.

* When you Generate F/W or Save As you will be asked if you want a specification sheet saving. This is a spreadsheet of all the parameters and set values.

8.1.4 REVIEW DEVICE FIRMWARE DETAILS

The FTB Gui allows users to collect key firmware details from a device by connecting it to a computer.

Note: When connecting the controller to the computer, ensure to only use a Sollatek interface cable.

1. Connect the FTB interface cable to the 6-way data port on the top of the FTB and the USB port on your computer.
2. Connect the controller to the mains supply (Live & Neutral), then turn the power ON
3. Open the FTB Configuration Interface.
4. Click the Device Info button on the right-hand side of the window.

5. Details from the FTB will be read and a pop-up window will appear when all details have been collected.

Note: This may take a few minutes.

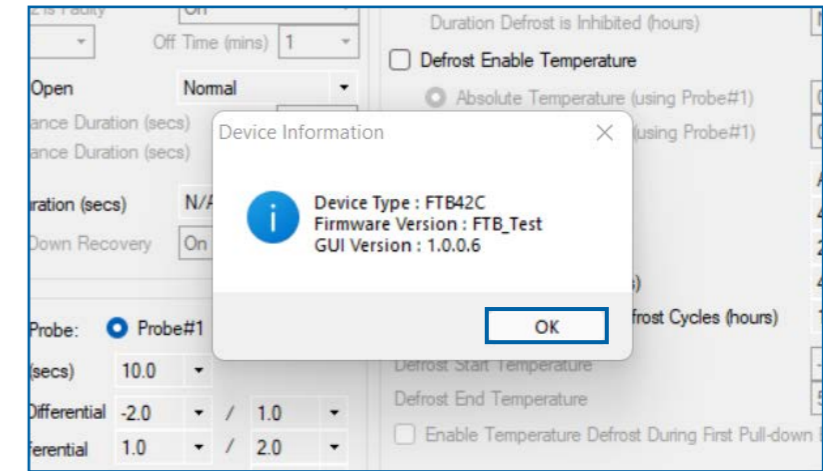

6. Click Ok to close the window.

8.2 REMOTE CONFIGURATION

Some parameters are configurable via the smart device application or via the buttons of a display (if connected), please refer to the application/display instructions or contact Sollatek for more details.

Parameters configurable via the display:

- Set-point Normal (Compressor Cut-out)
- Differential Normal (Compressor Cut-in)
- Set-point Eco (Compressor Cut-out)
- Differential Eco (Compressor Cut-in)
- Door closure duration to trigger energy saving
- Display Off-set (difference between the display temperature and the actual temperature)



9. PROGRAMMING



FTB firmware and configuration can be updated via the Sollatek Product Programmer device (SPP02).

The SPP02 can be programmed directly from the controller configuration software or the SPP visual programmer (refer to SPP Visual Programmer User Instructions for details on this method) and then uploaded to the FTB.

PROGRAMMING THE SPP02

There are two ways of programming the SPP02 from the Controller Desktop Interface.

- From the main menu - for quick programming with an existing configuration file.
- From the parameter configuration window - for programming when you have made changes/checked the configuration.

Downloading Parameters from the Home window.

- Open the desktop interface on your PC.
- Plug the SPP02 into the USB port on your PC.
- Click Tools > Program. Select a recently saved configuration or alternatively click Browse to search for the required configuration file.

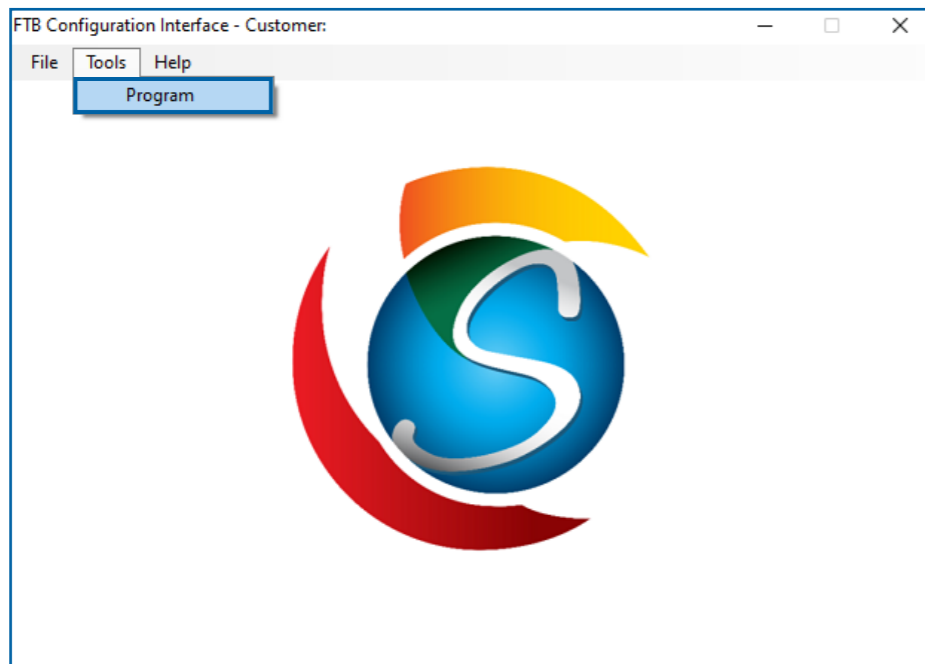

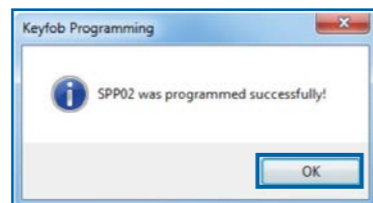

- If the file is selected from the recent configuration window, then click proceed to start uploading, alternatively select a file from the file window then programming will automatically start when you open the file.
- During the programming of the SPP02, the green LED labelled  on the SPP02 will light up and remain on as the data is being downloaded.
- The green LED will start flashing on successful downloading and then turn OFF. A success message will also appear on the screen. Click OK to close the message box. The SPP02 can now be removed from the computer.

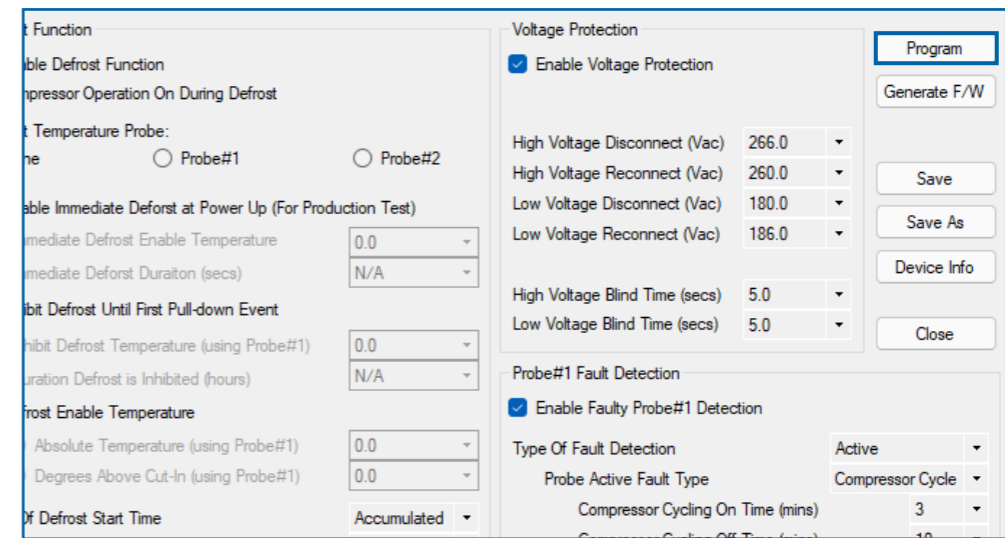

Downloading Parameters from the Parameter Configuration Window.

- Open and edit/create a configuration to match your requirement.
- Plug the SPP02 into the USB port in your computer, if plugging in for the first time please wait for all the drivers to be installed before proceeding, this may take several minutes.
- Click the Program button in the top right corner of the parameter configuration window.



- During the programming of the SPP02, the  LED on the SPP02 will light up and remain on as the data is being downloaded.
- On successful downloading, the  LED will start flashing and then turn OFF. A success message will also appear on the screen.
- Click OK to close the message box. The SPP02 can now be removed from the computer.

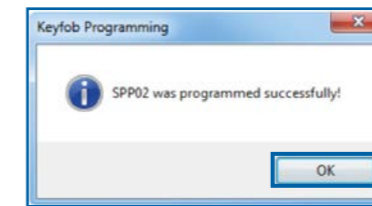





PROGRAMMING THE FTB



WARNING!

Isolate the supply before programming. Failure to do so can result in damage to equipment and electrical shock. This Equipment is to be serviced by trained personnel only.

- Connect the mini-USB connector of the SPP02 to the mini-USB port on the extension cable.
- Connect the 6-way connector of the extension cable to the 6-way Data port on the FTB.
- Press the button on the side of the SPP02 programmer. The  LED will light up and will remain on as the FTB is being programmed. The  LED on the FTB will also light up.
- On Completion the  LED will start flashing and turn OFF. The FTB  LED will also turn OFF.
- Unplug the SPP02 and extension cable from the unit. Reconnect mains to the FTB. The FTB is now ready for use.

Note: If you have any problems during programming or want to use the SPP Visual software to upload to the SPP02, then please refer to the SPP02 Visual Programmer User Instructions for more details and troubleshooting.



10. PARAMETERS

10.1 HARDWARE CONFIGURATION

DESCRIPTION	UNIT	RANGE
Number of Outputs	Number	1, 2, 3 or 4
Number of Temperature Probes	Number	1 or 2
Temperature Unit		°C or °F
Enable Door Switch		Yes or No

Number of Outputs

Select the number of connected outputs.

- 1 = Compressor
- 2 = Compressor + Aux 1
- 3 = Compressor + Aux 1 + Aux 2
- 4 = Compressor + Aux 1 + Aux 2 + Aux 3

Number of Temperature Probes

Select the number of connected temperature probes.

- 1 = Connect regulating probe to P1.
- 2 = Connect regulating probe to P1 and another probe to P2.

Temperature Unit

Select the temperature unit used by the FTB.

°C = Degree Celsius.

°F = Degree Fahrenheit.

Note: Once a temperature range has been selected, all temperature values will be converted accordingly. If a display is connected to the FTB, the display by default will display the temperature in this value.

Enable Door Switch

Select whether a door switch is connected to D-SW.

No = Door switch is disabled.

Yes = Door switch is enabled. You will now be able to set compressor actions based on a door event. Probe #2 will become de-active for "Defrost Temperature Probe".

10.2 RELAY CONFIGURATION (RELAY #2/#3/#4)

DESCRIPTION	UNIT	RANGE
Type of Load	Compressor, Evap Fan, Cond Fan, Light, Heater, Other	
Operation When Compressor is On	On, Off, Cycling, Heater, Light Control	
Cycling On Time (mins)	Minutes	1 to 255
Cycling Off Time (mins)	Minutes	1 to 255
Operation When Compressor is Off	On, Off, Cycling, Heater, Light Control	
Cycling On Time (mins)	Minutes	1 to 255
Cycling Off Time (mins)	Minutes	1 to 255
Operation During Defrost	On, Off, Cycling, Heater, Light Control	
Cycling On Time (mins)	Minutes	1 to 255
Cycling Off Time (mins)	Minutes	1 to 255
Operation When Probe#1 if Faulty	On, Off, Cycling, Heater, On/Cycling, Same as Comp, Light Control	
Cycling On Time (mins)	Minutes	1 to 255
Cycling Off Time (mins)	Minutes	1 to 255

Operation When Probe#2 if Faulty	On, Off, Cycling, Heater, On/Cycling, Same as Comp, Light Control	
Cycling On Time (mins)	Minutes	1 to 255
Cycling Off Time (mins)	Minutes	1 to 255
Operation When Door is Open	Normal, Off, On	
Door Open Response Time (secs)	Seconds	N/A, 1 to 255
Door Close Response Time (secs)	Seconds	N/A, 1 to 255
Compressor Initial ON Duration	Seconds	N/A, 1 to 25
Operation When in Recovery Time Delay	Off or On	

Type of Load

Select the type of load connected to the relay.

Operation When Compressor is ON

Select the operation of the relay when the compressor is ON.

On = Relay will turn ON (if OFF) and remain ON when the compressor is ON.

Off = Relay will turn OFF (if ON) and remain OFF when the compressor is ON.

Cycling = Relay will cycle ON / OFF for the defined periods while the compressor is ON.

Heater = Relay will turn ON (if OFF) when the temperature is less than the heater cut-in value and turn OFF (if ON) when the temperature is more than the heater cut-out value during compressor ON.

Light Control = Relay will turn ON (if OFF) when the compressor is ON during normal mode but will turn OFF (if ON) when the compressor is ON during energy-saving mode.

Cycling ON Time

The duration the relay will turn ON for while the compressor is ON. After this, the relay will turn OFF.

Cycling OFF Time

The duration the relay will turn OFF for while the compressor is ON. After this, the relay will turn ON.

Operation When Compressor is Off

Select the operation of the relay when the compressor is OFF.

On = Relay will turn ON (if OFF) and remain ON when the compressor is OFF.

Off = Relay will turn OFF (if ON) and remain OFF when the compressor is OFF.

Cycling = Relay will cycle ON / OFF for the defined periods while the compressor is OFF.

Heater = Relay will turn ON (if OFF) when the temperature is less than the heater cut-in value and turn OFF (if ON) when the temperature is more than the heater cut-out value during Compressor OFF.

Light Control = Relay will turn ON (if OFF) when the compressor is OFF during normal mode but will turn OFF (if ON) when the compressor is OFF during energy-saving mode.

Cycling ON Time

The duration the relay will turn ON for while the compressor is OFF. After this, the relay will turn OFF.

Cycling OFF Time

The duration the relay will turn OFF for while the compressor is OFF. After this, the relay will turn ON.

Operation During Defrost

Select the operation of the relay during defrost mode.

ON = Relay will turn ON (if OFF) and remain ON during defrost mode.

OFF = Relay will turn OFF (if ON) and remain OFF during defrost mode.

Cycling = Relay will cycle ON / OFF for the defined periods during defrost mode.

Heater = Relay will turn ON (if OFF) when the temperature is less than the heater cut-in value and turn OFF (if ON) when the temperature is more than the heater cut-out value during defrost.

Light Control = Relay will turn ON (if OFF) during defrost mode in normal mode but will turn OFF (if ON) during defrost in energy-saving mode.

Cycling ON Time

The duration the relay will turn ON during defrost mode. After this, the relay will turn OFF.

Cycling OFF Time

The duration the relay will turn OFF during defrost mode. After this, the relay will turn ON.



Operation When Probe#1 Faulty

Select the operation of the relay when probe #1 is faulty.

ON = Relay will turn ON (if OFF) and remain ON until probe #1 fault has been fixed.

OFF = Relay will turn OFF (if ON) and remain OFF until probe #1 fault has been fixed.

Cycling = Relay will cycle ON / OFF for the defined periods until probe #1 fault has been fixed.

Heater = Relay will turn ON (if OFF) when the temperature is less than the heater cut-in value and turn OFF (if ON) when the temperature is more than the heater cut-out value until probe #1 fault has been fixed.

On/Cycling = Relay will be ON when the compressor is ON. When the compressor is OFF, the relay will cycle ON / OFF for the defined periods until probe #1 fault has been fixed.

Same as Comp = Relay will operate the same as the compressor until probe #1 fault has been fixed.

Light Control = Relay will turn ON (if OFF) when probe #1 is faulty in normal mode but will turn OFF (if ON) when probe #1 is faulty in energy-saving mode.

Cycling ON Time

The duration the relay will turn ON for while probe #1 is faulty. After this, the relay will turn OFF.

Cycling OFF Time

The duration the relay will turn OFF for while probe #1 is faulty. After this, the relay will turn ON.

Operation When Probe#2 Faulty

Select the operation of the relay when probe #2 is faulty.

ON = Relay will turn ON (if OFF) and remain ON until probe #2 fault has been fixed.

OFF = Relay will turn OFF (if ON) and remain OFF until probe #2 fault has been fixed.

Cycling = Relay will cycle ON / OFF for the defined periods until probe #2 fault has been fixed.

Heater = Relay will turn ON (if OFF) when the temperature is less than the heater cut-in value and turn OFF (if ON) when the temperature is more than the heater cut-out value until probe #2 fault has been fixed.

On/Cycling = Relay will be ON when the compressor is ON. When the compressor is OFF, the relay will cycle ON / OFF for the defined periods until probe #2 fault has been fixed.

Same as Comp = Relay will operate the same as the compressor until probe #2 fault has been fixed.

Light Control = Relay will turn ON (if OFF) when probe #2 is faulty in normal mode but will turn OFF (if ON) when probe #2 is faulty in energy-saving mode.

Cycling ON Time

The duration the relay will turn ON for while probe #2 is faulty. After this, the relay will turn OFF.

Cycling OFF Time

The duration the relay will turn OFF for while probe #2 is faulty. After this, the relay will turn ON.

Operation When Door is Open

Select the operation of the relay when a door event occurs.

Normal = Relay will ignore the door event and operate as defined with the compressor.

Off = Relay will turn OFF (if ON) and remain OFF until the door has been closed. It will then resume normal operation depending on the FTB mode.

On = Relay will turn ON (if OFF) and remain ON until the door has been closed. It will then resume normal operation depending on the FTB mode.

Door Open Response Time

The minimum duration for the door to remain open before the relay will turn OFF or ON.

Door Close Response Time

The duration for the door to remain closed before the relay will resume normal operation.

Compressor Initial ON Duration

The minimum time after the compressor has turned ON, before the relay is allowed to turn ON.

Operation When in Post Drip Down Recovery

Select the operation of the relay when the FTB is in Post Drip Down Recovery mode.

ON = Relay will turn ON (if OFF) and remain ON during Post Drip Down Recovery mode.

OFF = Relay will turn OFF (if ON) and remain OFF during Post Drip Down Recovery mode.

10.3 TEMPERATURE CONTROL

DESCRIPTION	UNIT	RANGE
Regulation Temperature Probe		Probe#1 or Probe#2
Temperature Blind Time (secs)	Seconds	0 to 125
Normal Mode		
Set Point	°C / °F	-30 to +30°C / -22 to +86°F
Differential	°C / °F	1 to 5°C / 1.8 to 9°F
Eco Mode Settings		
Set Point	°C / °F	-30 to +30°C / -22 to 86°F
Differential	°C / °F	1 to 5°C / 1.8 to 9°F
Temperature Display Off-set Value	°C / °F	-10 to +10 / -18 to +18
Low Temperature Alarm	°C / °F	-40 to 0°C / -40 to +32°F

Regulation Temperature Probe

Select the temperature probe used as the regulation temperature probe.

Probe 1 = Regulating probe connected to P1.

Probe 2 = Regulation probe connected to P2. Only available if 2 is selected from "Number of Temperature Probes".

Temperature Blind Time

The duration that the regulation temperature probe reading will be ignored after the compressor switches ON.

Normal Mode Set-Point

The temperature at which the compressor will turn OFF when the system is running in Normal mode. The compressor will remain ON until the temperature reaches the Cut-Out temperature.

Normal Mode Differential

The temperature differential (difference from the set-point) at which the compressor will turn ON when the system is running in Normal mode. If the temperature is below the temperature (set-point + differential), the compressor will remain OFF.

Eco Mode Set-Point

The temperature at which the compressor will turn OFF when the system is running in energy-saving mode. The compressor will remain ON until the temperature reaches the Cut-Out temperature.

Eco Mode Differential

The temperature differential (difference from the set-point) at which the compressor will turn ON when the system is running in energy-saving mode. If the temperature is below the temperature (set-point + differential), the compressor will remain OFF.

Temperature Display Off-set Value

The difference between the live temperature reading from probe #1 and the displayed temperature.

Low Temperature Alarm

The regulation temperature which triggers a low-temperature alarm, this will only be indicated via a display. The controller will resume normal operation however if this is triggered there is often a fault to be investigated.

10.4 ENERGY SAVING

DESCRIPTION	UNIT	RANGE
Enable Energy Saving		Yes or No
Door Open Duration to Exit Energy Saving (secs)	Seconds	N/A, 1 to 60
Energy Saving Max Duration (hours)	Hours	N/A, 1 to 24
Energy Saving Min Duration (mins)	Minutes	N/A, 1 to 240
Door Close Duration To Start Energy Saving (hours)	Hours	N/A, 2 to 8



Door Close Duration - Point of Sale	Hours	N/A, 1 to 10
Normal Mode Min Duration (hours)	Hours	N/A, 1 to 24

Enable Energy Saving

Select whether Energy Saving is active. Energy-saving is a feature whereby the cut-in/cut-out values are set higher, therefore reducing the cooling demand required from the compressor.

No = Energy Saving is disabled. The FTB will only operate in normal mode. All other energy-saving parameters will be de-active.
Yes = Energy Saving is enabled. Based on set parameters, the FTB will switch automatically between normal and energy-saving modes.

Door Open Duration to Exit Energy Saving

The minimum duration of a door open event, whilst in set-back mode before the FTB will revert to normal mode.

Energy Saving Max Duration

The maximum duration that the FTB will remain in set-back mode before reverting to normal mode cut-in and cut-out temperature values.

Energy Saving Min Duration

The minimum duration that the FTB will remain in set-back mode before reverting to normal mode. Regardless of a door-open event, if the set time has not been satisfied, the FTB will remain in energy-saving mode.

Door Close Duration to Start Energy Saving

The duration, without any door activity before the FTB will enter set-back mode.

Note: The timer will start during the initial pull-down.

Door Close Duration - Point of Sale (PoS)

The minimum duration for no door openings before the FTB will consider any door opening as the start of the day (PoS). Energy saving will be forced to terminate one hour before the next anticipated PoS (i.e. 23 hours after the current PoS).

Normal Mode Min Duration

The minimum duration that the FTB must be in normal mode before allowing energy-saving mode to initiate. After this time has elapsed, and Door Close Duration to Start Energy Saving has been respected, the FTB will enter energy-saving mode.

For example: Normal Mode Min Duration is set to 6 hours ; Door Close Duration to Start Energy Saving is set to 2 hours

After 3 hours of operation in normal mode, there is no door activity for 2 hours. The FTB will resume in normal mode as the Normal Mode Min Duration has not been met. After 6 hours and no more door openings, the cooler will immediately enter energy-saving mode as both Normal Mode Min Duration and Door Close Duration to Start Energy Saving have been satisfied.

10.5 DELAYS AND TIMERS

DESCRIPTION	UNIT	RANGE
Compressor Relay Off Protection Delay (secs)	Seconds	0 to 600
Protection Delay Initial Bypass Count	Number	N/A, 1 to 60
Delay Between Loads (secs)	Seconds	0 to 60

Compressor Relay OFF Protection Delay

The minimum time the compressor must be OFF, before turning ON. If the compressor is OFF for longer than the set duration, then this delay will not be added before switching the compressor ON.

Protection Delay Initial Bypass Count (for use in testing only)

The number of controller start-ups, in which the Compressor Relay OFF Protection Delay will be ignored. This will result in the compressor turning ON as soon as the FTB is powered up.

Note: The Compressor Relay OFF Protection Delay will still be respected during operation.

Delay Between Loads

The minimum time delay between one relay turning ON and another being allowed to turn ON.

10.6 DEFROST FUNCTION

DESCRIPTION	UNIT	RANGE
Enable Defrost Function		Yes or No
Compressor Operation On During Defrost		Yes or No
Defrost Temperature Probe		None, Probe#1 or Probe#2
Enable Immediate Defrost at Power Up (for production test)		Yes or No
Immediate Defrost Enable Temperature	°C / °F	N/A, 0 to 25°C / 32 to 77°F
Immediate Defrost Duration	Seconds	N/A, 1 to 60
Inhibit Defrost Until First Pull-down Event		Yes or No
Inhibit Defrost Temperature (using Probe#1)	°C / °F	N/A, 0 to 25°C / 32 to 77°F
Duration Defrost is Inhibited (hours)	Hours	N/A, 1 to 255
Defrost Enable Temperature		Yes or No
Absolute Temperature (using Probe#1)	°C / °F	N/A, -38 to +25°C / -36.4 to +77°F
Degrees Above Cut-In (using Probe#1)	°C / °F	N/A, 0 to 20°C / 0 to 36°F
Type of Defrost Start Time		Real, Accumulated or Continuous
Defrost Start Time (hours)	Hours	N/A, 1 to 255
Defrost Duration (mins)	Minutes	N/A, 1 to 255
Minimum Defrost Duration (mins)	Minutes	N/A, 1 to 255
Minimum Duration Between Defrost Cycles (hours)	Hours	N/A, 1 to 255
Defrost Start Temperature	°C / °F	N/A, -38 to +25°C / -36.4 to +77°F
Defrost End Temperature	°C / °F	N/A, -38 to +25°C / -36.4 to +77°F
Enable Temperature Defrost During First Pull-down		Yes or No
Pre-Defrost Relays Off Delay	Seconds	N/A, 1 to 255
Drip Down Relays Off Delay	Seconds	N/A, 1 to 255
Post Drip Down Recover Time Delay	Seconds	N/A, 1 to 255
Post Drip Down Recover Temperature Override	°C / °F	N/A, -38 to +25°C / -36.4 to 77°F
Enable Defrost Emergency Mode (when defrost probe is faulty)		Yes or No
Emergency Mode Defrost Start Time (hours)	Hours	N/A, 1 to 255
Emergency Mode Defrost End Time (mins)	Minutes	N/A, 1 to 255
Enable Defrost During Probe#1 Active Faulty Mode		Yes or No
Enable Defrost During Probe#2 Active Faulty Mode		Yes or No

Enable Defrost Function

Select whether defrost is active.

No = Defrost is disabled. All defrost parameters become de-active and the FTB will not go into defrost.

Yes = Defrost is enabled. FTB will act according to the set parameters.

Compressor Operation On During Defrost

Select if the compressor is ON during defrost mode.

No = Compressor will turn OFF (if ON) and remain OFF during defrost.

Yes = Compressor will turn ON (if OFF) and remain ON during defrost (for Hot Gas defrost).

Defrost Temperature Probe

Select the temperature probe used to determine the defrost by temperature function.

None = Defrost will start and end with time only.

Probe 1 = Defrost probe connected to P1.

Probe 2 = Defrost probe connected to P2. Only available if 2 is selected from "Number of Temperature Probes".

Enable Immediate Defrost at Power Up

Select whether defrost is entered immediately when the FTB is powered ON.



No = FTB will operate normally on power-up according to set parameters and will only enter defrost when other defrost conditions are satisfied.

Yes = Defrost starts on power-up depending on the Immediate Defrost Enable Temperature.

Immediate Defrost Enable Temperature

The maximum temperature sensed by the defrost probe at power-up for defrost to be entered. If set to N/A, the FTB will enter defrost mode at power-up regardless of the defrost temperature.

Immediate Defrost Duration

The duration the FTB will stay in defrost mode from power-up before resuming normal operation.

Note: Immediate defrost will not terminate with defrost end temperature, it will ONLY be terminated when defrost duration has been satisfied. If the defrost duration is set to N/A, immediate defrost will terminate after 10 minutes.

Note: Immediate defrost is intended for production tests only and not for field operation. Ensure this is disabled for field units.

Inhibit Defrost until First Pull-down Event

Select whether defrost is enabled during the first pull-down event. The First pull-down event finishes when the compressor cycles OFF for the first time due to the temperature dropping below the cut-out value.

No = Defrost is enabled. Defrost can take place during the first pull-down event if defined defrost conditions are met.

Yes = Defrost is disabled. Defrost will not take place until the first pull-down event has finished.

Inhibit Defrost Temperature (using Probe #1)

The regulation temperature sensed after a power-up event, below which defrost will not be inhibited anymore.

Duration Defrost is Inhibited

The duration of the first pull-down event and therefore the period of defrost will be inhibited. After this time the FTB will resume normal operation and defrost will be enabled as per the set parameters.

Defrost Enable Temperature

Select whether defrost is disabled depending on the regulation probe temperature.

No = Defrost is enabled regardless of the regulation probe and will be initiated by the set parameters.

Yes = Defrost will be disabled if the regulation temperature is above the set temperature even if other defrost parameters are satisfied. If the regulation temperature is below the set value, defrost will be initiated as normal.

Absolute Temperature (using Regulation Probe)

The maximum regulation temperature before the defrost function is disabled.

Degrees Above Cut-in (using Regulation Probe)

The temperature differential between the cut-in temperature and the regulation temperature that the defrost function will be disabled.

Defrost Start Timer Type

Select the type of timer to start a defrost cycle.

rEL: Real-Time = The defrost start time will continuously count regardless of whether the compressor is ON or OFF and the defrost will start when the timer value exceeds the value of Defrost Start Time (if enabled).

aCC: Accumulated Time = The defrost start timer will count only when the compressor is ON and stops counting (not resetting) when the compressor is OFF, resulting in counting the accumulated durations during which the compressor has been ON. The defrost will start when the timer value exceeds the value of Defrost Start Time (if enabled).

Cnt: Continuous Timer = The defrost start timer will count only when the compressor is ON and resets to zero whenever the compressor is OFF. The defrost will start when the timer value exceeds the value of Defrost Start Time (if enabled).

Defrost Start Time

The duration between the finish of a defrost cycle and the start of the next one, if not started due to temperature.

Defrost Duration

The duration of a defrost cycle, if not ended due to temperature.

Minimum Defrost Duration

The minimum allowable time for a defrost cycle. The Defrost cycle will not end until this time has elapsed regardless of whether Defrost End Time or Defrost End Temperature has been met.

Minimum Duration Between Defrost Cycles

The minimum time between the finish of one defrost cycle and the start of the next defrost cycle. The next defrost cycle will not start until this time has elapsed regardless of whether Defrost Start Time or Defrost Start Temperature has been met.

Defrost Start Temperature

The temperature that a defrost cycle will be initiated, assuming the FTB has satisfied the "minimum Duration Between Defrost Cycles" value. This will only be respected if the defrost probe is not faulty.

Defrost End Temperature

The temperature at which the defrost cycle will terminate, assuming the FTB has been in defrost for longer than the "minimum Defrost Duration" value. This will only be respected if the defrost probe is not faulty.

Enable Temperature Defrost During First Pull-Down

Select if the FTB goes into defrost when first powered up.

No: Defrost ON start-up is disabled. FTB will only enter defrost according to other set defrost parameters.

Yes: Defrost will initiate once the FTB is powered up.

Pre-Defrost Relays Off Delay

The duration between defrost start parameters being satisfied (temperature or time) and the FTB entering defrost mode. During this time the compressor will turn OFF and the outputs will act accordingly to the compressor OFF configuration.

Drip Down Relays Off Delay

The duration after the defrost end parameters have been satisfied before the FTB will enter Drip Down Recovery Mode. During this period the compressor and outputs will be OFF.

Post Drip Down Recover Time Delay

The duration for the FTB to remain in Drip Down Recover mode before Resuming normal operation. During Drip Down Recover the compressor will turn ON and the other outputs will operate accordingly to the configuration.

Post Drip Down Recover Temperature Override

The temperature at which post drip down recover mode will terminate, if not ended due to time.

Enable Defrost Emergency Mode (when defrost probe is faulty)

Select whether Emergency defrost is active.

No = Emergency defrost is disabled. FTB will resume respecting set defrost parameters.

Yes = Emergency defrost is enabled. FTB will respect the below parameters.

Emergency Mode Defrost Start Time

The duration between the start of a defrost and the start of the next defrost when the defrost probe is faulty.

Emergency Mode Defrost End Time

The duration of defrost during emergency defrost.

Enable Defrost During Probe#1 Active Faulty Mode

Select if defrost is enabled when probe #1 is faulty and Probe #1 "Type of Fault Detection" is set to Active.

No = Defrost is disabled. FTB will remain in normal operation when Probe #1 is faulty.

Yes = Defrost is enabled. FTB will continue to enter defrost as per the set parameters even when probe #1 is faulty.

Enable Defrost During Probe#2 Active Faulty Mode

Select if defrost is enabled when probe #2 is faulty and Probe #2 "Type of Fault Detection" is set to Active.

No = Defrost is disabled. FTB will remain in normal operation when Probe #2 is faulty.

Yes = Defrost is enabled. FTB will continue to enter defrost as per the set parameters even when probe #2 is faulty.



10.7 VOLTAGE PROTECTION

DESCRIPTION	UNIT	RANGE
Enable Voltage Protection		Yes or No
High Voltage Disconnect (Vac)	Vac	75 to 300
High Voltage Reconnect (Vac)	Vac	75 to 300
Low Voltage Disconnect (Vac)	Vac	75 to 300
Low Voltage Reconnect (Vac)	Vac	75 to 300
High Voltage Blind Time (secs)	Seconds	0 to 25
Low Voltage Blind Time (secs)	Seconds	0 to 25

Enable Voltage Protection Feature

Select whether voltage protection is active.

No = Voltage protection is disabled. All other voltage protection parameters become de-active and FTB will not respond to High or Low Voltage.

Yes = Voltage Protection is enabled. FTB will act according to the set parameters.

High Voltage Disconnect

The maximum allowable voltage before the FTB disconnects power to all the outputs.

High Voltage Reconnect

The voltage, which the FTB will reconnect power to all the outputs after a High Voltage Disconnect event.

Low Voltage Disconnect

The minimum allowable voltage before the FTB disconnects power to all the outputs.

Low Voltage Reconnect

The voltage, which the FTB will reconnect power to all the outputs after a Low Voltage Disconnect event.

High Voltage Blind Time

The duration that the voltage must be higher/lower than the High Voltage Disconnect/High Voltage Reconnect before disconnecting/reconnecting power to the compressor and outputs.

Low Voltage Blind Time

The duration that the voltage must be lower/higher than the Low Voltage Disconnect/Low Voltage Reconnect before disconnecting/reconnecting power to the compressor and outputs.

10.8 DOOR SWITCH OPERATION

DESCRIPTION	UNIT	RANGE
Compressor Operation When Door Switch is Open		Normal or Off
Door Switch Open Persistence Duration (secs)	Seconds	N/A, 1 to 255
Door Switch Close Persistence Duration (secs)	Seconds	N/A, 1 to 255

Compressor Operation when Door Switch is Open

Select the compressor operation when a door event occurs.

Normal = The compressor ignores the door event and resumes normal operation.

OFF = The compressor will turn OFF and remain OFF during a door open event. When the door is closed, the compressor will resume normal operation.

Door Switch Open Persistence Duration

The duration that the door remains open before the compressor will switch OFF. If the door is open for less than the set value, the compressor will resume normal operation.

Door Switch Close Persistence Duration

The duration for the door to remain closed after a door open event before the compressor will turn back ON.

10.9 HEATER FUNCTION

DESCRIPTION	UNIT	RANGE
Heater Cut-In Temperature	°C / °F	N/A, -38 to +25°C / -36.4 to +77°F
Heater Cut-Out Temperature	°C / °F	N/A, -38 to +25°C / -36.4 to +77°F
Enable Other Aux Always On When Heater is On		Yes or No

Note: The heater function will only be enabled if Relay #2 or #3 is configured to operate in heater mode during any of their operation modes (operation when compressor is cycling on/operation when compressor is cycling off/operation during defrost/operation when probe#1 is faulty/operation when probe#2 is faulty is set to "heater").

Heater Cut-in Temperature

The temperature at which the heater will turn ON. If the temperature is below this value, the heater will remain OFF.

Heater Cut-Out Temperature

The temperature at which the heater will turn OFF. The heater will remain ON until the temperature reaches the Cut-Out temperature.

Enable Other Aux Always On When Heater is On

Select whether the other connected output will always be ON when the heater relay is ON.

No = Output will resume normal operation based on set parameters (relay configuration).

Yes = Output will turn ON and remain ON while the heater is ON.

10.10 PROBE FAULT DETECTION (PROBE #1/#2)

DESCRIPTION	UNIT	RANGE
Enable Faulty Temperature Probe Detection		Yes or No
Type of Fault Detection		Active or Passive
Probe Active Fault Detection		Compressor Off or Cycle
Compressor Cycling On Time	Minutes	1 to 255
Compressor Cycling Off Time	Minutes	1 to 255

Enable Faulty Temperature Probe Detection

Select whether the FTB detects probe fault.

No = Probe fault detection disabled. FTB will operate according to normal settings.

Yes = Probe fault detection enabled. FTB will act according to the set parameters.

Type of Fault Detection

Select the compressor operation when a fault is detected.

Active = The compressor will operate according to the set parameters.

Passive = Fault will be indicated through the LED. FTB will operate according to normal settings.

Probe Active Fault Detection

Select the compressor operation during an Active Fault Detection.

Compressor OFF = Compressor will turn OFF (if ON) and remain OFF until the probe fault has been fixed.

Compressor Cycle = Compressor will cycle ON and OFF for defined periods to maintain cooling.

Compressor Cycling ON Time

The duration the compressor will remain ON when the probe is faulty.

Compressor Cycling OFF Time

The duration of the compressor will Remain OFF when the probe is faulty.



11. SPECIFICATION

REFRIGERATION CONTROL		
Temperature Control Method	Air or Evaporator	
Temperature Control Range	-30 to +35°C (-22 to +95°F)	
Temperature Time Delay	1 to 125 s	
Defrost Control	Timed, Active or Manual (via a display)	
Advanced Defrost Mode	Pre/Post Defrost, Emergency Defrost	
Energy Saving	Temperature Setback, Fan Cycling, Lights OFF	
Input Type	2x Temperature Sensor & 1x Door Switch	
Temperature Probe Type	10 KΩ NTC ($\beta_{25/50}$: 3950 k)	
Output Control	Compressor, Lights, Evaporator fan, Reverse Fan, or Heater	
	Relay	Control
Output 1 (Compressor Relay)	16 A, 250 V	8(6) A, 230 Vac, 100k cycles
Output 2/Relay #4 (Defrost)	10 A, 250 V	8 A, 230 Vac, 50k cycles
Output 3/Relay #3 (Evaporator Fan)	5 A, 250 V	2 A, 230 Vac, 100k cycles
Output 4/Relay #2 (Lights)	5 A, 250 V	1 A, 230 Vac, 30k cycles
Maximum Input Current	11 A Total ON Current	
Intelligent Time Delay	0 to 600 s	
Refrigerant Compatibility	CO ₂ & Hydrocarbon	
LEDs	1 x Red Status/Mode LED	
POWER & VOLTAGE PROTECTION		
Nominal Voltage	115 V / 230 V	
Operating Voltage Range	90 to 300 V	
Withstand Voltage	Up to 320 V	
Working Frequency	Auto-sense 45 to 75 Hz	
Type of Protection	High / Low voltage, Spike / Surge & Frequency	
High / Low Voltage Blind time	0 to 25 s	
Surge Protection	6.5 kA, <10 ns, 160 J	
Over Voltage Category	Category II	
Power Consumption	11.5 VA	
CONNECTOR		
Input Connector	3 pairs of 0.11" (2.80 mm) Fast-On	
Power / Output Connector	6-way (2x3) Connector	
Data / Programming	6-way Connector	
ENVIRONMENTAL		
IP Rating	IP20 Electronics: IP65 (PCB Encapsulated)	
Operating Temperature	-20 to +60°C (-4 to +140°F)	
Operating Humidity	<90% RH non-condensing	
Shipping/storage Temperature	-25 to +60°C (-13 to +140°F)	
CERTIFICATION / STANDARDS		
Product Certification	CE, CB, IEC 60730-1, IEC 60730-2-9, UL 60730-1, UL 60730-2-9, EN60079, EN61000	
Flammability	UL94 V-0 @ 1.5 mm, GWFI: 960°C, GWIT: 850°C	
Pollution Degree	2	
MECHANICAL		
Mounting	M4 self-tapping pozidriv screws	
Unit Dimensions	112.0 x 89.0 x 30.0 mm	
Unit Weight	Approx. 190 g	

12. ACCESSORIES

INPUT SENSORS



PRODUCT CODE	PRODUCT DESCRIPTION
9TM16025BS	T Probe 6.0/2.5/16 10K BK24 C1A
9TM16025WS	T Probe 6.0/2.5/16 10K WT24 C1A
9TM16035BS	T PROBE 6.0/3.5/16 10K BK24 C1A
9TM16035WS	T Probe 6.0/3.5/16 10K Wt24 C1A
9TM16040WS	T PROBE 6.0/4.0/16 10K WT24 C1A
9TM16060BS	T Probe 6.0/6.0/16 10K BK24 C1A
9TM16060WS	T Probe 6.0/6.0/16 10K WT24 C1A
9W10120BS	D SWITCH N/O SPST 2.0/BK24/C1S
9W10120WS-Y	D Switch 2xN/O SPST 2.0/WT26/C1S

DISPLAY



PRODUCT CODE	PRODUCT DESCRIPTION
92394B00	FDM4B 30mm Blue 2 Digit Display
92394R00	FDM4R 30mm Red 2 Digit Display
92394B0S	FDM4B-S 30mm Blue 2 Digit Display
92394R0S	FDM4R-S 30mm Red 2 Digit Display
92394W0S	FDM4W-S 30mm White 2 Digit Display
92395BD0	FDM5B-D 50mm Blue 2 Digit Display
92395RD0	FDM5R-D 50mm Red 2 Digit Display
92395WD0	FDM5W-D 50mm White 2 Digit Display
92395B0S	FDM5B-S 50mm Blue 2 Digit Display
92395R0S	FDM5R-S 50mm Red 2 Digit Display
92395W0S	FDM5W-S 50mm White 2 Digit Display
92403104	FTB- FDM4/5 Disp Cable 3.0m
92403107	FTB- FDM4/5 Disp Cable 3.5m
92403108	FTB- FDM4/5 Disp Cable 4.1m
92403109	FTB- FDM4/5 Disp Cable 6.0m

CONNECTIVITY DEVICES



PRODUCT CODE	PRODUCT DESCRIPTION
9530BR4B	GBR 4 Remote BLE Module + Battery
8M293488	Cable 1x6 way to uUSB 1.0m

PROGRAMMING



PRODUCT CODE	PRODUCT DESCRIPTION
90500400-D	SPP02D FCAX3/FCR/FCZ/FDE/FDM/FSP/FTB
92403106	SPP02 to Cabelshell 6way2.54mm
8M293508	FTB Interface Cable

13. VERSION HISTORY

VERSION	DATE COMPLETE	DESCRIPTION	REVIEWED BY
1.0	30/11/2016	Initial Version	Anmar Rassam
2.0	12/12/2018	Section 12 (parameter table updated)	Neville Barreto
3.0	04/05/2023	Reformatted and all sections updated	Neville Barreto





SOLLATEK UK LTD.

Tel: +44 (1753) 214 500
sales@sollatek.com
www.sollatek.com

Sollatek (UK) Ltd. Sollatek House, Waterside Drive, Langley, Slough SL3 6EZ UK

©Sollatek (UK) Limited 2023. All Rights Reserved. SOLLATEK and the SOLLATEK device are the trade marks of the Sollatek group of companies.. No part of this manual may be reprinted or copied without the prior written permission of Sollatek.

Product specifications and other information in this manual are subject to change without prior notice to make improvements.

The information in this document has been carefully checked and is believed to be accurate. Nevertheless Sollatek assumes no responsibility for any errors or omissions.

