



## FDM5-S

50mm, Touch Button LED Display Module for Sollatek Refrigeration Controllers

## USER INSTRUCTIONS

Important: This manual contains important safety instructions. Before using this product please read all instructions carefully. Keep this manual handy for reference.

## CONTENTS

<b>1. INTRODUCTION</b>	<b>3</b>
1.1 DISPLAY DESCRIPTION	3
1.2 DISPLAY FEATURES	3
1.3 TECHNICAL SPECIFICATION	3
1.4 FRONT PANEL	4
<b>2. INSTALLATION</b>	<b>5</b>
2.1 DISPLAY DIMENSION & PANEL CUT OUT	5
2.2 PANEL MOUNTING THE DISPLAY	5
2.3 CONNECTING THE DISPLAY TO THE CONTROLLER	5
<b>3. OPERATION</b>	<b>6</b>
3.1 LEVEL 1 (HOME DISPLAY)	6
3.2 LEVEL 2 (MENU OPTIONS)	7
3.3 LEVEL 3 (VALUE CONFIGURATION)	8
<b>4. ALARMS</b>	<b>9</b>
<b>5. PROGRAMMING</b>	<b>11</b>

## SAFETY AND DISPOSAL



### INSTALLATION

Mounting of the unit must be in accordance with orientation as specified in the "installation" section.

### TEMPERATURE

The Sollatek device must only be subjected to temperatures as specified in the "Technical Specifications" section of this manual.

### VIBRATION AND IMPACT

The device MUST be installed in such a way as to be protected from impact in operation. Do not hit or drop the device.

### NO SERVICEABLE PARTS

There are no serviceable parts inside the device. Do NOT open the housing.

### FIT FOR PURPOSE

The Sollatek device must only be used for the purpose and functions described in this manual. The device must only be connected to Sollatek controllers stated in the manual.

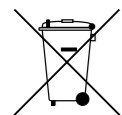

### DISPOSAL

Sollatek devices are subject to the EU directive 202/96/EC and may also be subject to other national legislation for the safe disposal of e-waste. The device cannot be disposed of as municipal waste, and such waste should be collected and disposed of separately.

Sollatek devices comply with EU directive 2002/95/EC (RoHS).

## 1. INTRODUCTION

### 1.1 DISPLAY DESCRIPTION

The FDM5-S is a digital LED refrigeration display that displays the live temperature reading, alarms present, and operational status through 8 LED lit icons. Through the four capacitive touch display buttons, users can adjust eight saved controller parameters and manually change modes. The display has 2 x 7 segment digits that are 50mm in height. Modern, bright LEDs are used to enhance visibility and simplify reading. The displays are panel mounted and can be connected to the Sollatek FTB, FDE, and FCx3 controllers with a connection cable.

### 1.2 DISPLAY FEATURES

- View live cooler temperature and alarms
- 8 LED icon indicators to indicate the controller run mode
- LED display available in Red, Yellow, Blue, Green, and White
- Eight saved controller parameters and controller operational modes can be adjusted through the buttons on the display
- Passcode protected menu items
- 4 touch-sensitive buttons on the front of the unit
- Compact, simple panel mount design - Fits standard display panel apertures
- IP65 front for "washdown" resistance and harsh environments
- Fully Programmable via PC software or SPP programmer

### 1.3 TECHNICAL SPECIFICATION

<b>USER INTERFACE</b>	
Type	2x 7 Segment, each made from 14 SM LEDs
Height	50 mm
Colour	Red, Blue, Green, White, Yellow
Annunciators	1x Minus sign ; 1x Decimal point ; 8x Controller status icons
Button / Keypad	4 x touch buttons (front)
<b>ELECTRICAL</b>	
Power	Powered from Host
Connector	6-way connector for connecting to the controller
<b>ENVIRONMENTAL</b>	
Operating Temperature	-20°C to +55°C
Operating Humidity	95% RH non-condensing
IP Rating (Front)	IP65 (Washable)
IP Rating (Rear)	IP20 Conformal Coated PCB
<b>MECHANICAL</b>	
Mounting	Rear Panel Mount with 4x Clips
Unit Dimensions	128.0 x 90.0 x 24.7 mm
Unit Weight	Approx. 132 g



## 1.4 FRONT PANEL

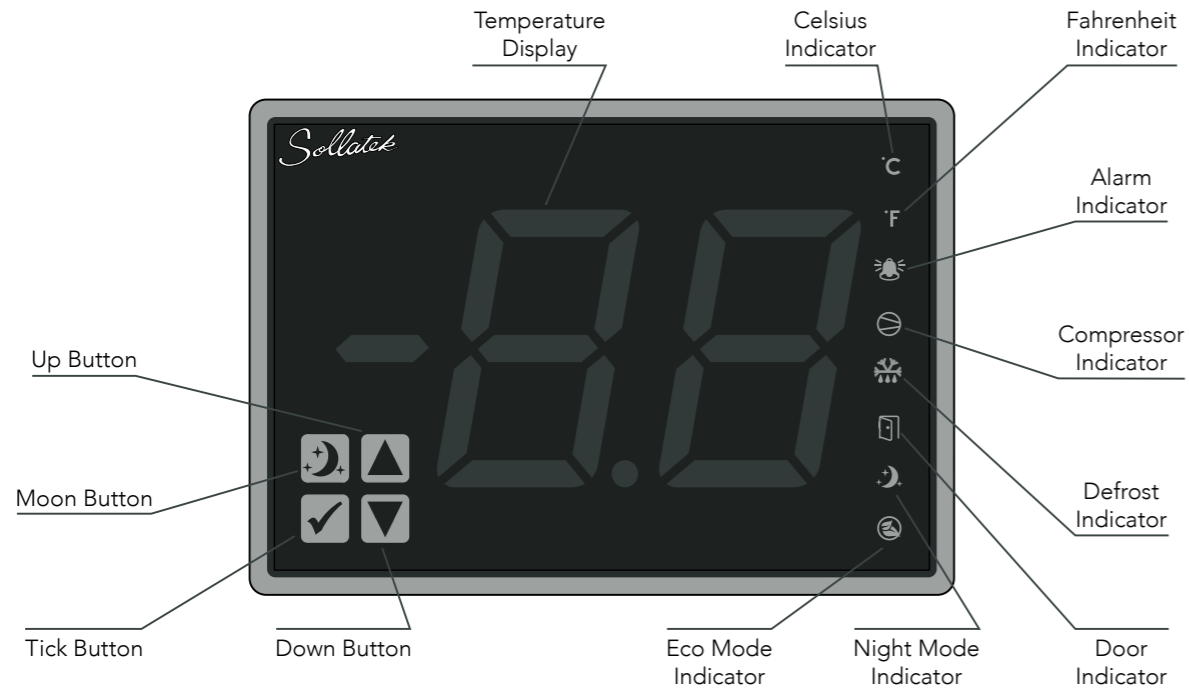

### 1.4.1 MEANINGS OF INDICATORS AND DISPLAY

- Temperature Display:** Displays the present temperature, status / alarm codes as well as the menu items and parameter values.  
*Note: The temperature will be displayed in the same unit of measurement (°C / °F) the controller is set with. To change this the controller must be reprogrammed.*
- Celsius Indicator:** ON when the controller is set to display temperatures in degrees Celsius
- Fahrenheit Indicator:** ON when the controller is set to display temperatures in degrees Fahrenheit
- Alarm Indicator:** ON when there is an alarm present, otherwise OFF
- Compressor Indicator:** ON when the compressor is ON, flashing when the compressor is OFF
- Defrost Indicator:** ON when the cooler is in Defrost mode, otherwise OFF
- Door Mode Indicator:** ON when the cooler door is OPEN, otherwise OFF
- Night Mode Indicator:** ON when the cooler is in Night mode, otherwise OFF
- Eco Mode Indicator:** ON when the cooler is in ECO mode, otherwise OFF

### 1.4.2 USING THE BUTTONS

- Moon Button:** Press (in level 1) to enter / exit eco mode  
 Press (in level 2/3) to return to the previous level
- Up Button:** Press to Increment menu / parameter value
- Tick Button:** Press to enter the next level / save parameter value
- Down Button:** Press to decrement menu item / parameter value
- Button Combination**  
 ▲ + ▼ Hold these buttons to Manually enter defrost mode

## 2. INSTALLATION

### 2.1 DISPLAY DIMENSION & PANEL CUT OUT

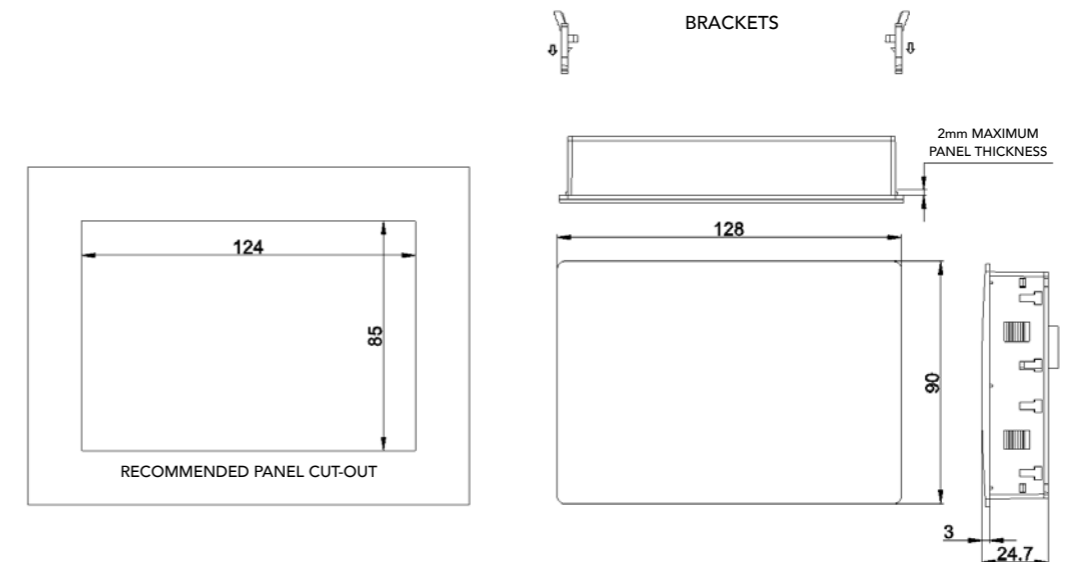

### 2.2 PANEL MOUNTING THE DISPLAY

- Cut a rectangle aperture in the panel of the cooler where the display is to be located as per the panel cut diagram.  
*Note: The Maximum panel thickness must not exceed 2 mm for the FDM5-S to securely fit into position.*
- Ensure the hole is free of burrs and sharp edges. Insert the FDM5-S into the hole.
- Insert the side clips (2 per side) into the slots on either side of the body and slide these forward until they clip into position and are held securely in position against the mounting panel.

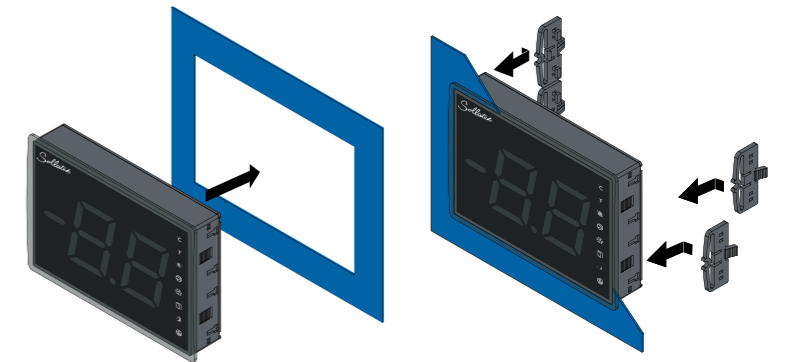

### 2.3 CONNECTING THE DISPLAY TO THE CONTROLLER



#### DANGER!

Isolate the supply to the cooler / controller before connecting /removing the display. Failure to do so can result in damage to equipment and electrical shock.  
 This equipment is to be installed or serviced by trained personnel only.

- At the rear of the FDM5-S display is the 6-pin male connector for connecting to the controller.
- Connect the female adaptor on one end of the connector cable to the port on the back of the display.
- Connect the other end of the connection cable to the data port on the controller.  
*Note: Refer to controller instructions to locate the data port.*
- Turn the power ON to the controller and the display will turn ON.

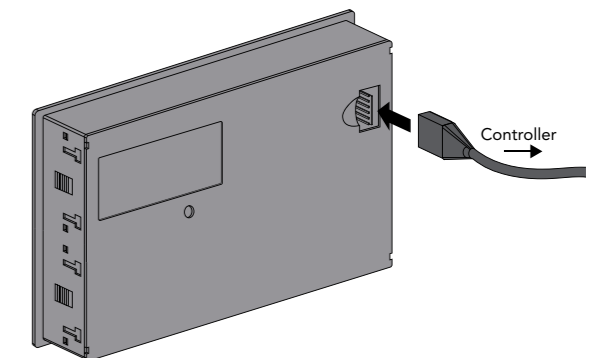

### 3. OPERATION

The FDM5-S has three levels of operation.

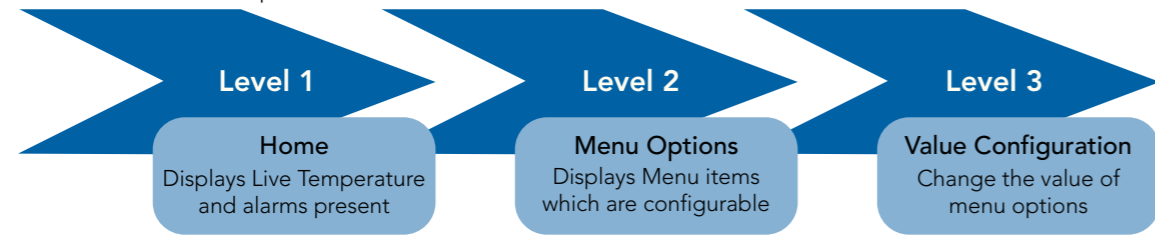

#### 3.1 LEVEL 1 (HOME DISPLAY)



The live temperature and controller mode/statuses are shown on this screen as well as any alarms.

#### DOOR OPENING

When the cooler's door is open, the display will flash between d0 and the live cooler temperature until the door is closed.

*Note: Door switch must be enabled in the controller configuration (configurable via the controller GUI)*



#### DEFROST MODE

When the controller is in defrost mode, the display will flash between df and the cooler temperature recorded just before entering defrost (FTB) or live cooler temperature (FDEx2).

*Note: Defrost must be enabled in the controller configuration (configurable via the controller GUI)*



To manually force the controller in defrost mode, press & hold together until the display beeps (about 5 seconds).

#### ECO MODE

When the controller is in Eco mode, the display will flash between Ec and the live cooler temperature.

*Note: Energy saving must be enabled in the controller configuration (configurable via the controller GUI)*



To manually force the controller in/out of Eco mode, press and the display will beep to and then will enter/exit eco mode.

#### 3.2 LEVEL 2 (MENU OPTIONS)

In level 1 press and hold for 2 seconds to enter level 2 - Menu options

##### 3.2.1 PASSCODE

Level 2 is protected by a passcode to prevent unauthorised changes to settings. The display will show:

The factory-set passcode is: .

*Note: Other passcodes are available but must be set by Sollatek. Speak to Sollatek if another passcode is required.*

Enter the 4 button passcode and then press to confirm:

- If the password is correct, the display will enter level 2 (menu items)
- If at any point the wrong button is pressed, the display will return to level 1 (Home)



##### 3.2.2 MENU ITEMS

###### COMPRESSOR CUT-OUT VALUE WHEN IN NORMAL MODE



The temperature to turn the compressor OFF.

Controller	Minimum Value	Maximum Value	Deviation Value
FTB	-30.0°C / -22°F	30.0°C / 86°F	0.5°C (-10 to +10), 1°C (<-10 & >10) / 1°F
FDEx2	-28.0°C / -18°F	45.0°C / 99°F	0.1/0.5/1.0°C/°F* (-10 to +10), 1°C/°F (<-10 & >10)

###### COMPRESSOR CUT-IN VALUE IN NORMAL MODE



FTB - The differential temperature from the set-point to turn the compressor ON.  
FDEx2 - The temperature value to turn the compressor ON.

Controller	Minimum Value	Maximum Value	Deviation Value
FTB	1°C / 1.8°F	5.0°C / 9°F	0.1°C / 0.2°F
FDEx2	-28.0°C / -18°F	45.0°C / 99°F	0.1/0.5/1.0°C/°F* (-10 to +10), 1°C/°F (<-10 & >10)

###### TEMPERATURE OFF-SET



The measured temperature can be adjusted to display an off-set temperature

Controller	Minimum Value	Maximum Value	Deviation Value
FTB / FDEx2	-10.0°C / -18°F	10.0°C / 18°F	0.5°C / 1°F

###### HOURS FOR DOOR CLOSED



The duration for the door to stay closed to start Energy saving mode

Controller	Minimum Value	Maximum Value	Deviation Value
FTB / FDEx2	2 Hours	8 Hours	1 Hour

### COMPRESSOR CUT-OUT VALUE WHEN IN ECO MODE

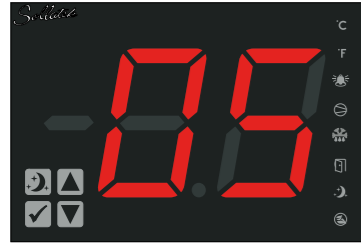

The temperature to turn the compressor OFF in ECO mode.

Controller	Minimum Value	Maximum Value	Deviation Value
FTB	-30.0°C / -22°F	30.0°C / 86°F	0.5°C (-10 to +10), 1°C (<-10 & >10) / 1°F
FDEx2	-28.0°C / -18°F	45.0°C / 99°F	0.1/0.5/1.0°C/°F* (-10 to +10), 1°C/°F (<-10 & >10)

### COMPRESSOR CUT-IN VALUE IN ECO MODE

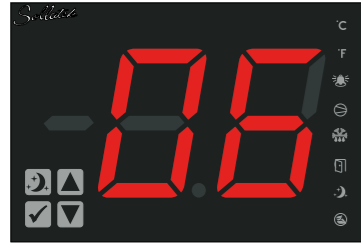

FTB - The differential temperature from the Eco set-point to turn the compressor ON.

FDEx2 - The temperature value to turn the compressor ON in Eco mode.

Controller	Minimum Value	Maximum Value	Deviation Value
FTB	1°C/1.8°F	5.0°C/9.0°F	0.1°C/0.2°F
FDEx2	-28.0°C / -18°F	45.0°C / 99°F	0.1/0.5/1.0°C/°F* (-10 to +10), 1°C/°F (<-10 & >10)

### DEFROST START TIMER



The duration between the finish of a defrost cycle and the start of the next one, if not started due to temperature.

Controller	Minimum Value	Maximum Value	Deviation Value
FTB	Not configurable via the display		
FDEx2	0 Hours	24 Hours	1 Hour

### DEFROST END TIMER

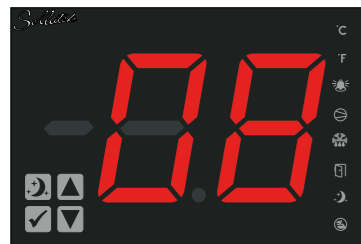

The duration of a defrost cycle if not ended due to temperature.

Controller	Minimum Value	Maximum Value	Deviation Value
FTB	Not configurable via the display		
FDEx2	0 Hours	99 Hours	1 Hour

Toggle through the menu options by pressing ▲ or ▼. To return to level 1 (home) press ☾.

\*Deviation will be according to the temperature resolution set in the controller GUI.

### 3.3 LEVEL 3 (VALUE CONFIGURATION)

In level 2 press ✓ and the display will enter level 3 (the desired parameter value)

Change the value by pressing ▲ or ▼. To save the changes, press ✓. The display will return to level 2 (Menu options).

To go back or to cancel any changes, press ☾ and the display will return to level 2 (Menu options).

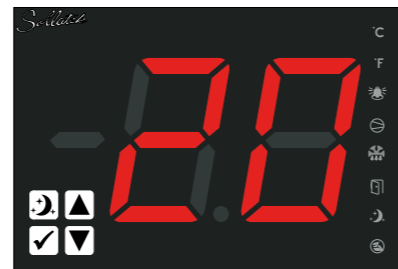

#### Parameter Not Configurable

Defrost parameters are not configurable via the display, the display will show "na" when the parameter is entered. Press ☾ to return to the menu item list (level 2)

## 4. ALARMS

### PROBE#1 FAULT

If the probe plugged into P1 in the controller is faulty or unplugged the display will flash alternately between P1 and the -40.

Note: Probe #1 fault detection must be enabled in the controller configuration (configurable via the controller GUI)



### PROBE#2 FAULT

If the probe plugged into P2 in the controller is faulty or unplugged the display will flash alternately between P2 and the live cooler temperature.

Note: Probe #2 fault detection must be enabled in the controller configuration (configurable via the controller GUI)



### LOW VOLTAGE

If the supply voltage to the fridge falls below the LVD of the controller, the display will flash alternately between UL and the live cooler temperature.

Note: Voltage protection must be enabled in the controller configuration (configurable via the controller GUI)

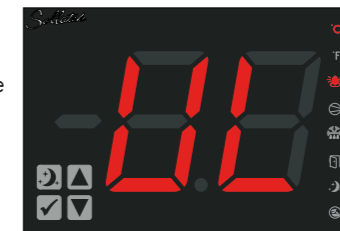

### HIGH VOLTAGE

If the supply voltage to the fridge rises above the HVD of the controller, the display will flash alternately between uh and the live cooler temperature.

Note: Voltage protection must be enabled in the controller configuration (configurable via the controller GUI)

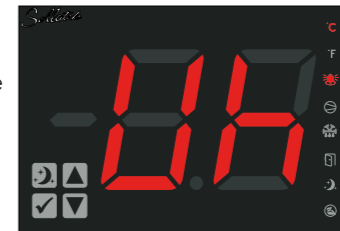

### COMPRESSOR ON-TIME MORE THAN 24 HOURS\*

If the compressor is consistently on for more than 24 hours, the display will flash alternately between Cr and the live cooler temperature.



### LOW TEMPERATURE\*

If the temperature in the fridge drops below the set value (configurable via the controller GUI), the display will flash alternately between tL and the live cooler temperature.



### HIGH TEMPERATURE\*

If the temperature in the fridge rises above 18°C for more than 6 hours after an initial pulldown has occurred, the display will flash alternately between tH and the live cooler temperature.

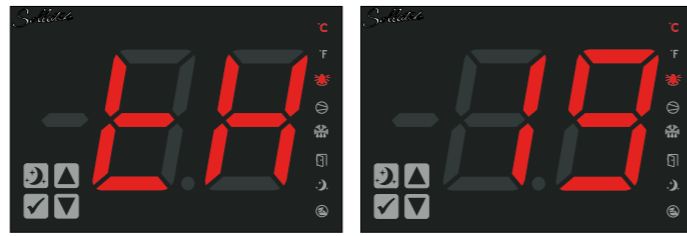

### COMMUNICATION ERROR

If the display is having trouble communicating with the controller, this could be because of a cable fault or controller issue, -- will flash on the display.



- If more than one alarm is present, the display will cycle all error codes and live cooler temperature.
- Error codes will flash until the errors have been resolved

\* Alarm currently unavailable with FDEx2 controllers. If the alarm is required, then please contact Sollatek.

## 5. PROGRAMMING

The FDM5-S can be programmed via the Sollatek SPP02 Product programmer.



### Downloading the settings on the SPP02.



- Open the SPP Visual Programmer Software, supplied by Sollatek.
- Plug the SPP02 Programmer into the computer's USB port, if plugging in for the first time please wait for all the drivers to be installed before proceeding.
- Select the programmer type: SPP02 and product type: FDM
- Enable and click on "Select Program Memory File". Load the .s19 firmware file into the software.
- Click the "Program SPP" button within the SPP Visual Programmer Software. The green LED labelled  will light up and remain on as the data is being downloaded.

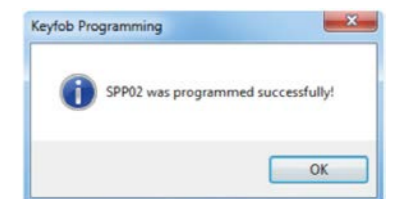

- On successful downloading, the green LED  will start flashing and then turn off. The below window will also appear on the screen.
- Click "OK" to close the window. You may now remove the device from the computer.



### Programming the FDM5-S

- Connect the mini-USB connector of the SPP02 to the mini-USB port on the extension cable.
- Connect the 6-way connector of the extension cable to the port on the back of the FDM5-S.
- Press the button on the side of the SPP02 programmer. The  LED will light up and will remain on as the FDM5-S is being programmed.
- On completion, the  LED will start flashing and turn OFF.
- Unplug the SPP02 and extension cable from the unit. Reconnect to the controller.

Note: If you have any problems during programming, please refer to the SPP Visual Programmer User Instructions for more details and troubleshooting.

## VERSION HISTORY

VERSION	DATE COMPLETE	DESCRIPTION	REVIEWED BY
1.0	18/09/2017	Initial Version	Ziad Azzabi
2.0	26/02/2021	Corrections & formatting	Ziad Azzabi
3.0	17/08/2021	Spanish alarm codes removed	Ziad Azzabi
4.0	10/06/2022	Corrections & updated format	Ziad Azzabi
5.0	30/09/2022	Menu item and value configuration updated	Ziad Azzabi



**SOLLATEK UK LTD.**

Tel: +44 (1753) 214 500  
sales@sollatek.com  
www.sollatek.com

©Sollatek (UK) Limited 2022. All Rights Reserved. SOLLATEK and the SOLLATEK device are the trade marks of the Sollatek group of companies.. No part of this manual may be reprinted or copied without the prior written permission of Sollatek.

Product specifications and other information in this manual are subject to change without prior notice to make improvements.

The information in this document has been carefully checked and is believed to be accurate. Nevertheless Sollatek assumes no responsibility for any errors or omissions.

Sollatek (UK) Ltd. Sollatek House, Waterside Drive, Langley, Slough SL3 6EZ UK

MJA	09/22
-----	-------

FDM5-S Instructions Manual v5 Sept 2022  
A/I: 10910283  
S/C: 74122316