



SOLLATEK DATA SHEET NO:

10910480

GBR / GBR-B

REMOTE BLUETOOTH CONNECTIVITY MODULE FOR SOLLATEK CONTROLLERS

Description

The GBR is a Bluetooth modem which can be connected to Sollatek controllers, EMD (Energy Management Device) or other Host Devices to give the device Bluetooth capabilities.

Using the smartphone app, users can view real-time telemetry and historical data transmitted from the Sollatek Host Device including: Cooler temperature, door openings and alarm status.

Furthermore, via the smartphone application users can upload telemetry data to an online portal for further analysis as well as view and set parameters of the Sollatek Controller / EMD remotely.

The GBR gives the ability for customer engagement via iBeacon and Eddystone BLE beaconing protocols.

GBR-B has a built-in battery, giving the ability to data sync even when there is no mains power.

Features

- Bluetooth Low Energy (BLE)
- Transmits Eddystone and iBeacon signals to allow nearby customer engagement
- Connect up to two devices including Sollatek Temperature controller and display
- Collects and stores data received from the Sollatek temperature controller/EMD and transmits to the mobile phone app
- Optional battery to enable data sync with no power. Battery lifetime of 5-7 years (GBR-B version).
- Contactless Asset Identification through Proximity
- Easily retrofitted to a Sollatek Host Device via a connecting cable
- Two indicator LEDs

Technical Specification

	GBR	GBR-B
Key Features	RF Connectivity Bluetooth low energy (BLE) connectivity to Host device Data Modem Eddystone and iBeacon	
Connectors	GBR to host device using serial data via Micro USB connector GBR to Secondary device using serial data via second Micro USB connector	
Memory	Internal Flash for storage of approx. 13,000 events Digital interfaces: UART	
Power	N/A	Power from Host device Ultra-low power design
Battery		Built in Primary battery with expected stand by lifetime of over 5yrs BR2477A 3V Nominal capacity 1000mAh
Mobile	App to display controller parameters: Temperature, Compressor status, Relay status, Alarm status etc. Android and iOS based smartphone App Over The Air (OTA) update of GBR & Sollatek EMD Firmware	
Mechanical	Mounting: 2x screws or double-sided adhesive pad (provided) Dimension: 52.0 x 34.0 x 22.3 mm 18 g 26 g Operating temperature: -40°C to 65°C IP rating: IP52*	
Certification	CB, IEC60950, EN301489-1, EN301489-17, EN55032, EN55024, EN300328, EN62479, EN55014	

* Not tested, subject to mounting orientation





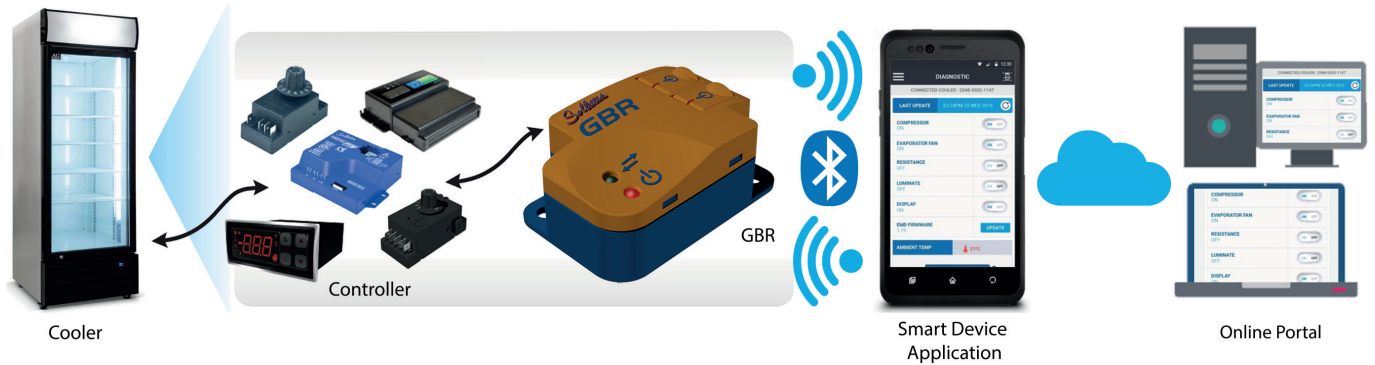

Typical application



Application Diagram



Model Compatibility

	GBR1 / GBR1-B		GBR2 / GBR2-B	GBR3 / GBR3-B		GBR4 / GBR4-B	
Supply Voltage	5 V		3.3 V	24 V		24 V	
Logic Voltage	5 V		3.3 V	3.3 V		5 V	
Host Device	FCZ 	FCR 	For Future Use	FFA 	JEA 	FTB 	FCAX3 

Dimensions

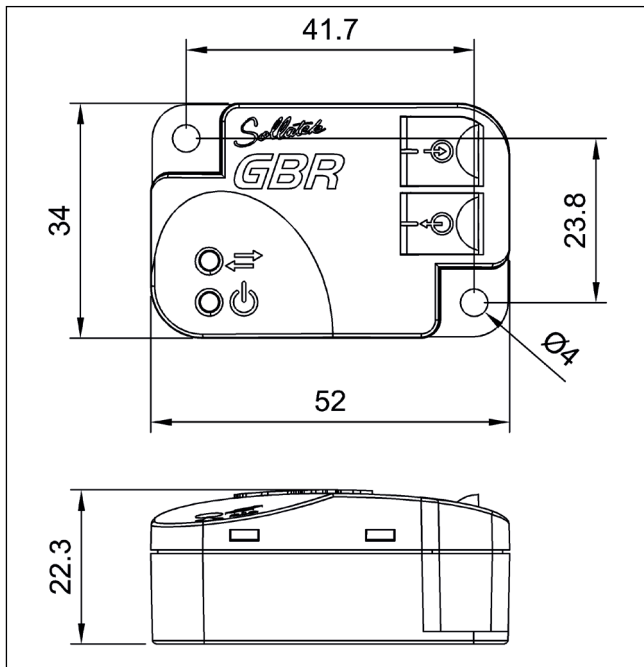

Stock No	Description
9530BR10	GBR1 Remote BLE Module
9530BR1B	GBR1-B Remote BLE Module + Battery
9530BR20	GBR2 Remote BLE Module
9530BR2B	GBR2-B Remote BLE Module + Battery
9530BR30	GBR3 Remote BLE Module
9530BR3B	GBR3-B Remote BLE Module + Battery
9530BR40	GBR4 Remote BLE Module
9530BR4B	GBR4-B Remote BLE Module + Battery

Mobile App - Cooler Live Image & Programmable Parameters

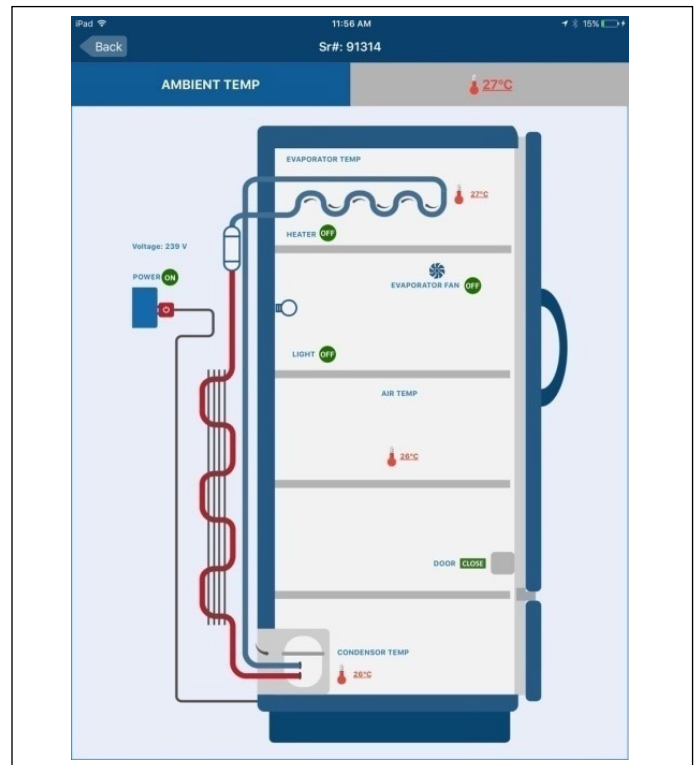

For more information on the Sollatek product range visit www.sollatek.com

